



# PLUS<sup>+</sup> SHADE OPEN ROLL MANUAL

## INSTALLATION INSTRUCTIONS

Rollashade.com  
info@rollashade.com  
951.245.5077

© Copyright Roll-A-Shade® Inc. All Rights Reserved.



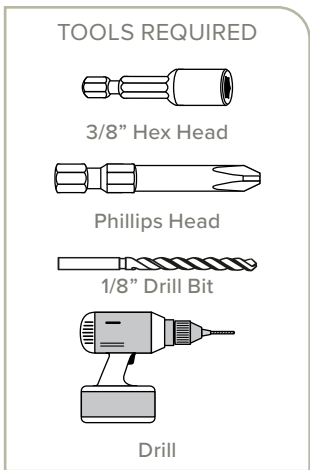
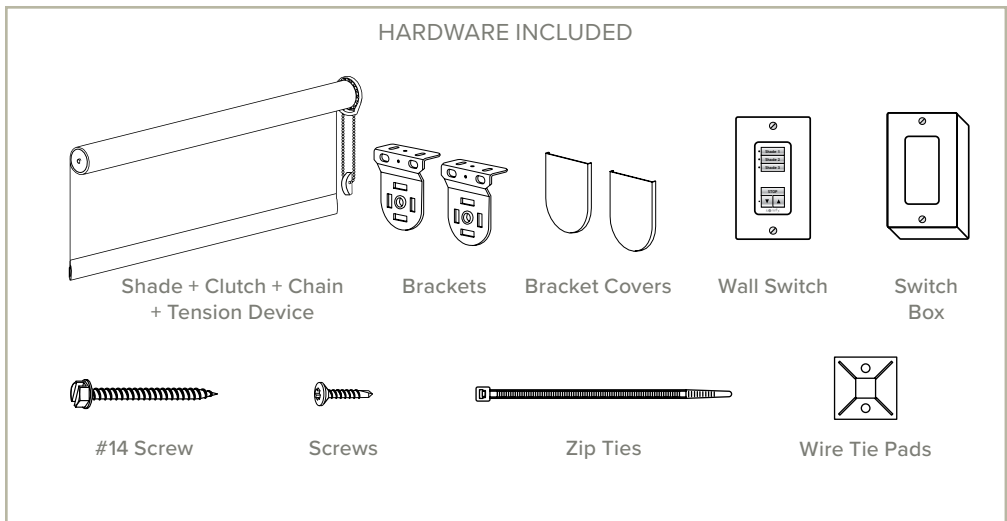

**1 INSIDE OR OUTSIDE APPLICATION**

**\*\*NOTE: ALL SHADES MAY BE PRE-PROGRAMMED TO SENSORS, REMOTES, AND/OR WALL SWITCHES UPON ARRIVAL\*\***

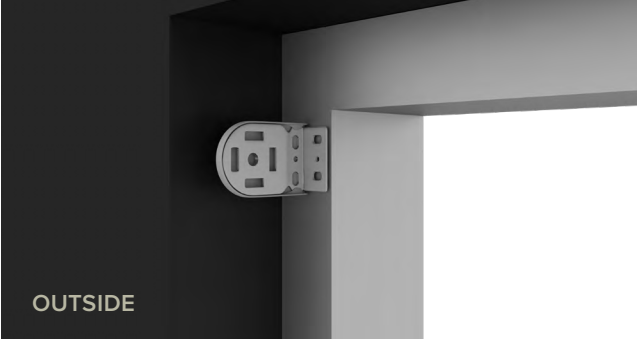
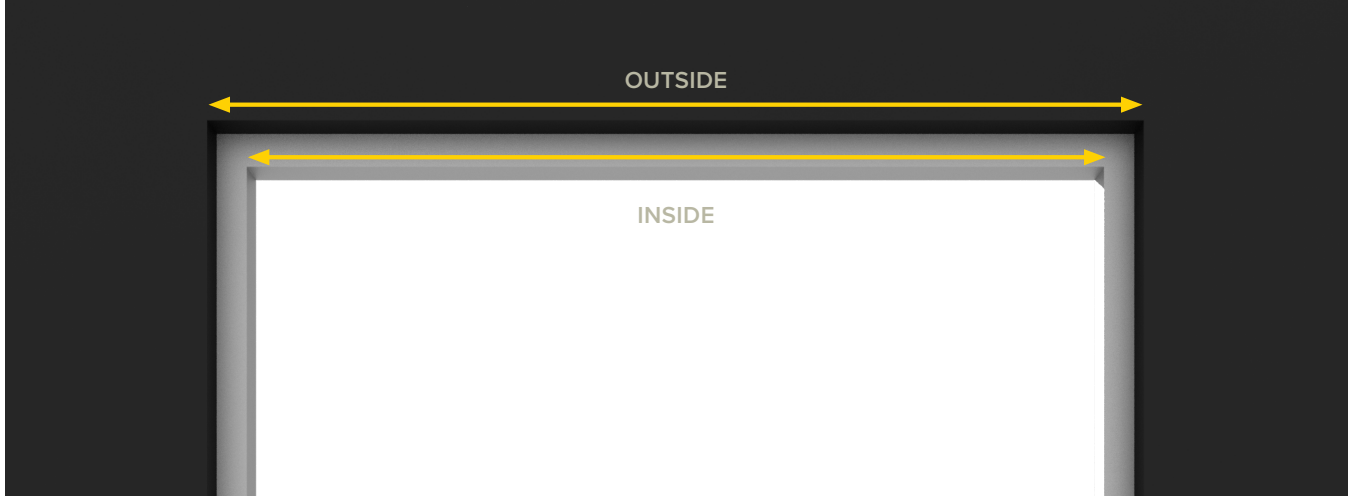

## 2 MOUNTING LOCATION

Place your first bracket in its mounting location and mark the screw holes. Place your second bracket in its mounting location and repeat the process.

A.



B.

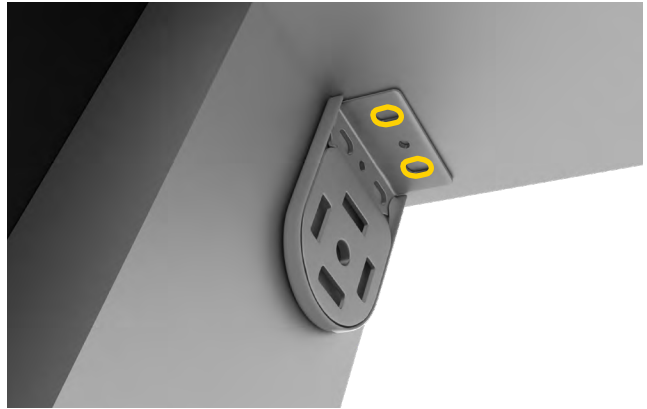

C.



## 3 SCREW INSTALLATION

Next, pre-drill your screw holes using a 1/8" drill bit. Install the brackets with the provided screws using the 1/4" hex head driver.

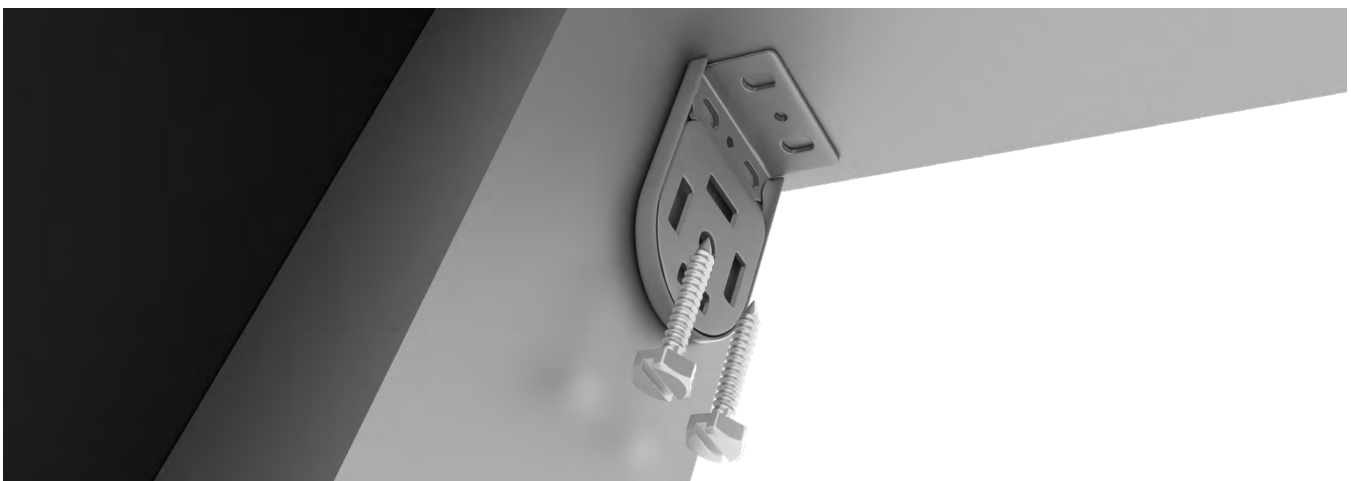

#### 4 ALIGNMENT

Check to make sure your brackets are level and aligned.

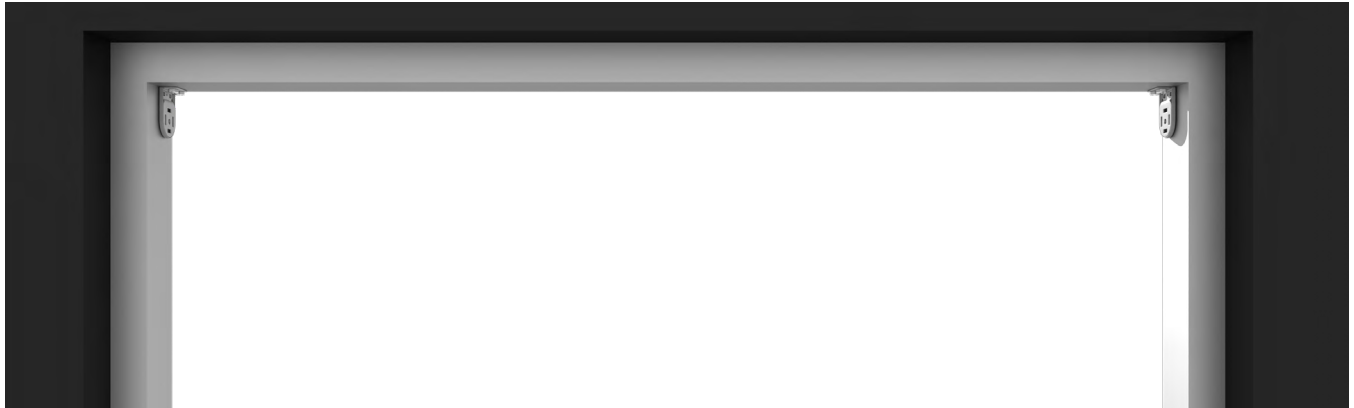

#### 5 SHADE PIN END INSTALLATION

Depress pin end and slide onto bracket until pin engages in center hole. Press idler shaft all the way to the bracket.

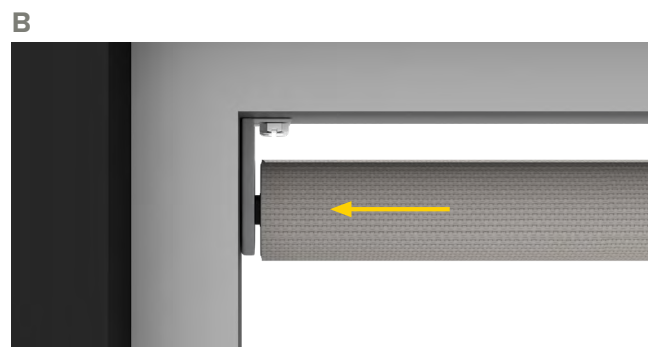

#### 5 CLUTCH END & TENSION DEVICE INSTALLATION

Lineup to clutch bracket. Push clutch into clutch bracket. Install tension device.

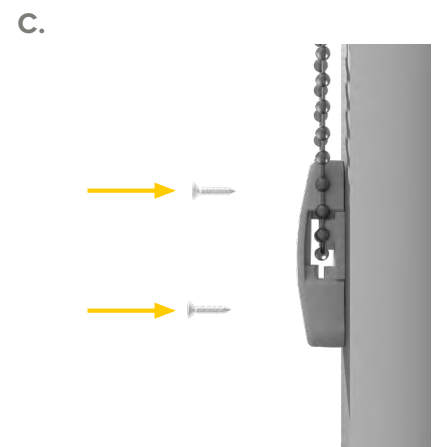
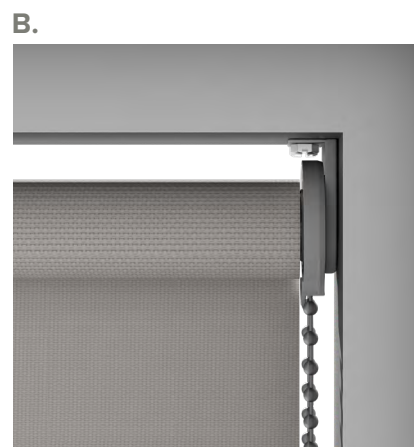
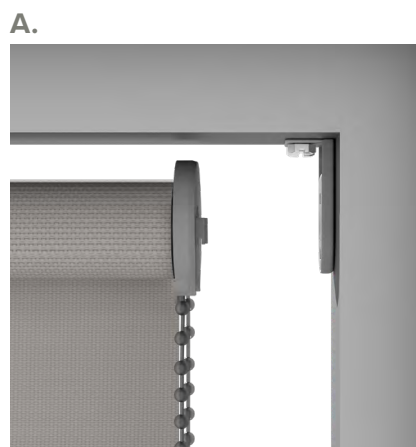

## 11 COMPLETED INSTALLATION

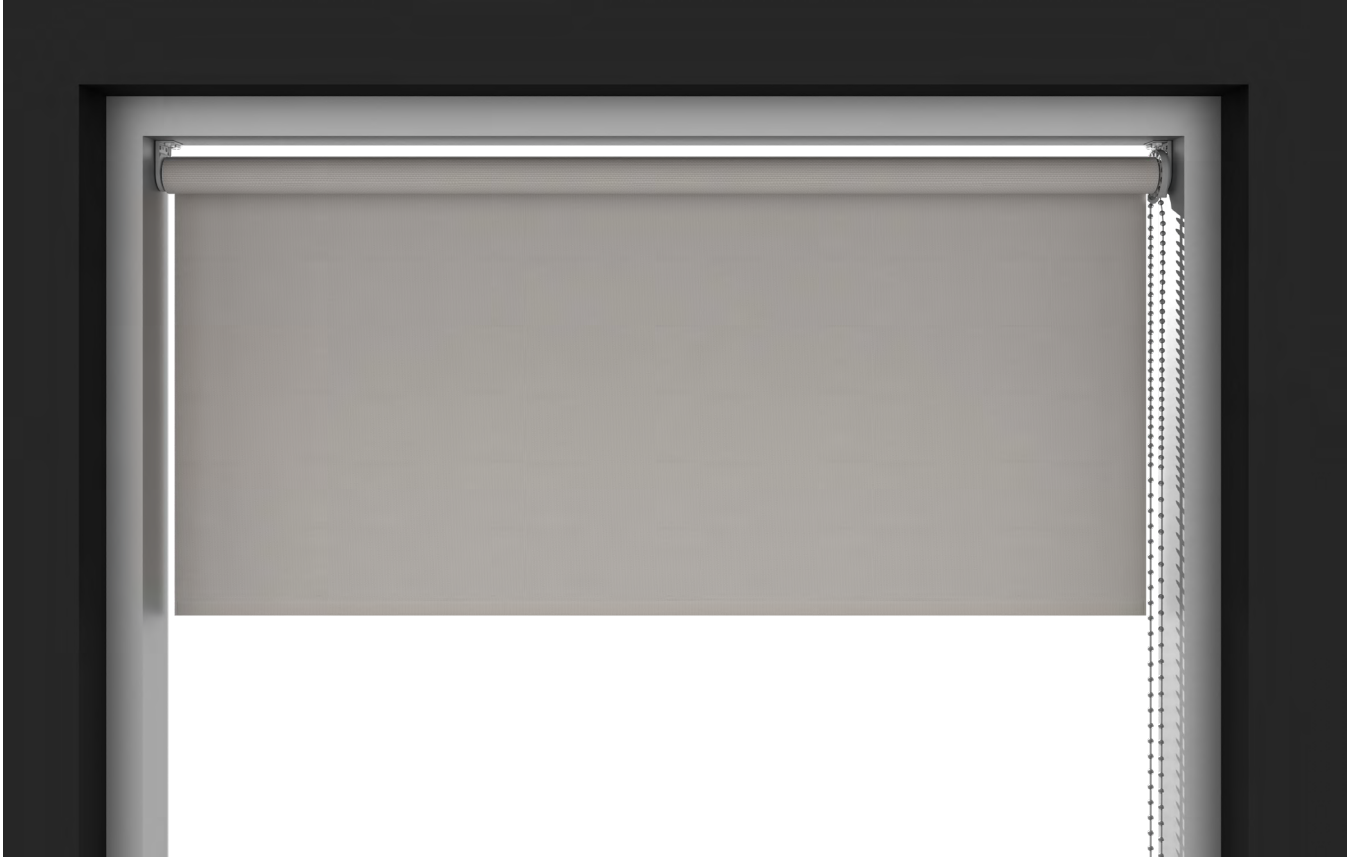



# TENSION DEVICE

## INSTALLATION INSTRUCTIONS

Rollashade.com  
info@rollashade.com  
951.245.5077

© Copyright Roll-A-Shade® Inc. All Rights Reserved.



HARDWARE INCLUDED

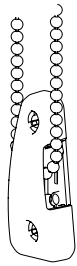

Tension Device + Chain

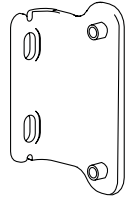

Tension Device Bracket



Short Screws



Screws

TOOLS REQUIRED

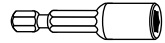

3/8" Hex Head

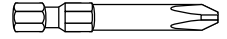

Phillips Head



1/8" Drill Bit

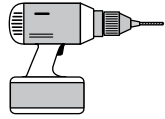

Drill

INSIDE OR OUTSIDE APPLICATION

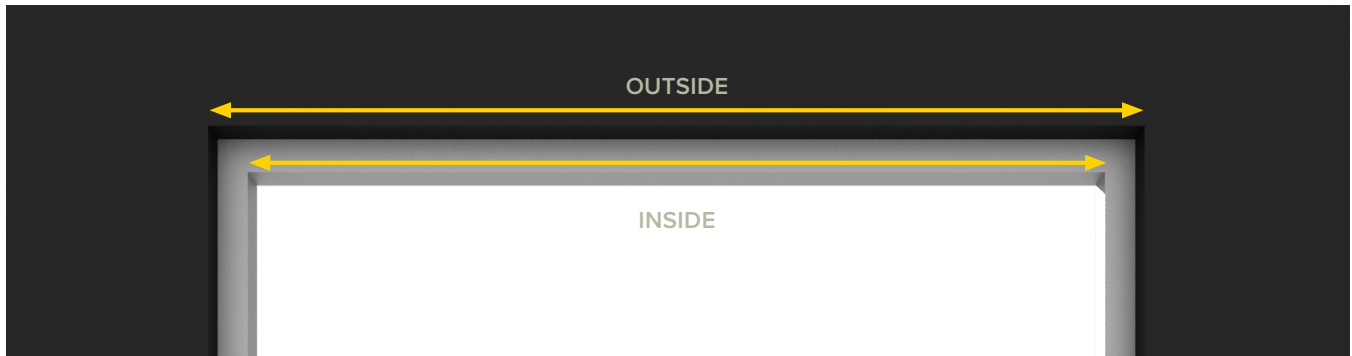

INSIDE



OUTSIDE

## INSIDE MOUNT & TENSION DEVICE INSTALLATION

Pull the Chainhold down until the chain is fully tensioned (plunger will be fully raised). Screw device into wall.

A

KEEP  
TENSION

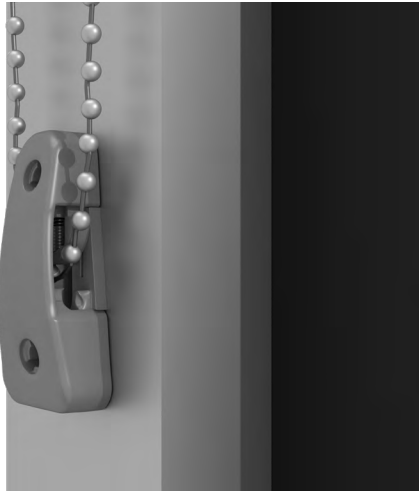

B



C

SECURE  
TENSION  
DEVICE



**NOTE:** Please make sure shade operates smoothly.



## OUTSIDE MOUNT & TENSION DEVICE INSTALLATION

With provided screws, install bracket first with large screws (use Chainhold marked screw hole locations as reference). Pull the Chainhold down until the chain is fully tensioned (plunger will be fully raised). Install Chainhold into bracket with small screws.

A

PULL CHAIN  
DOWN &  
MARK  
LOCATION



B

REMOVE  
TENSION  
DEVICE  
& DRILL

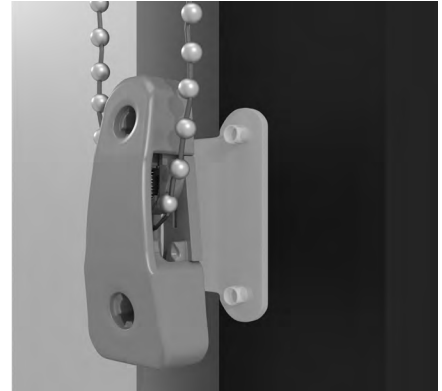

C

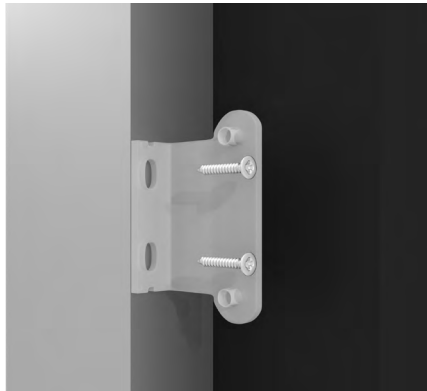

D

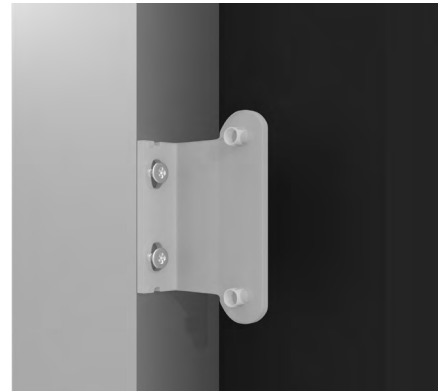

E

PLACE  
TENSION  
DEVICE ON  
BRACKET



F

SECURE  
TENSION  
DEVICE



**NOTE:** Please make sure shade operates smoothly.