



PLUS⁺ SHADE OPEN ROLL COUPLED

INSTALLATION INSTRUCTIONS

Rollashade.com
info@rollashade.com
951.245.5077

© Copyright Roll-A-Shade® Inc. All Rights Reserved.



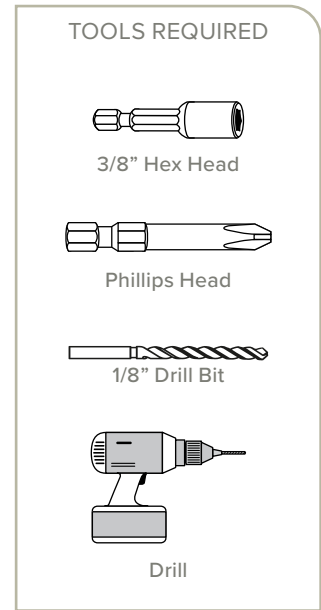
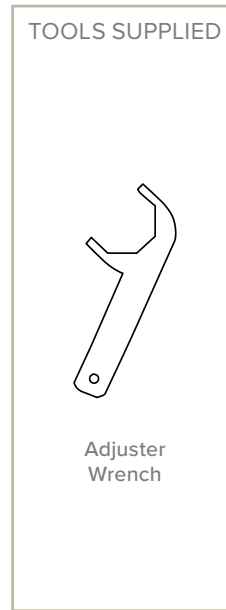
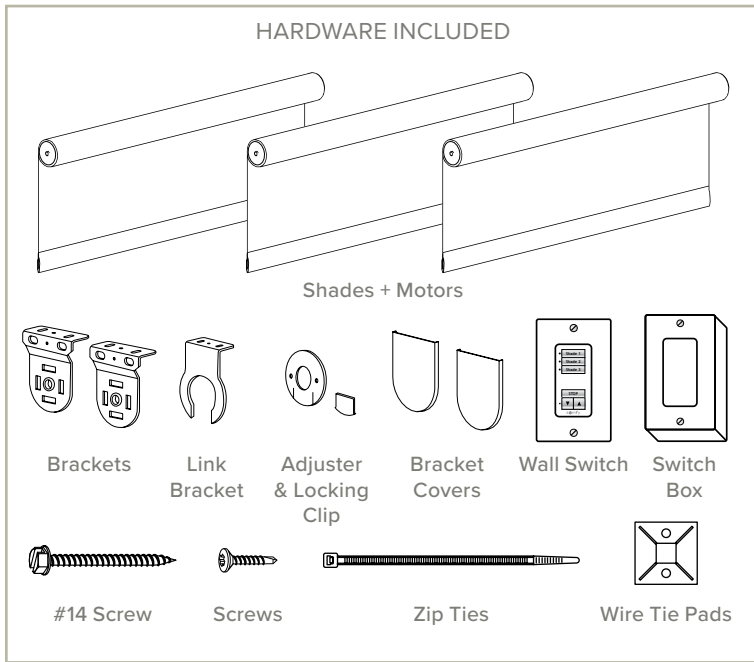

1 INSIDE OR OUTSIDE APPLICATION

****NOTE: ALL SHADES MAY BE PRE-PROGRAMMED TO SENSORS, REMOTES, AND/OR WALL SWITCHES UPON ARRIVAL****

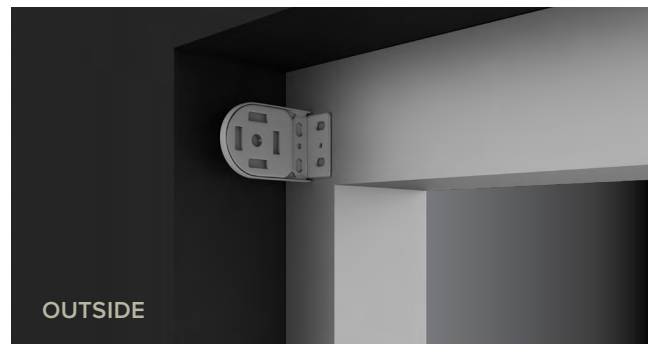
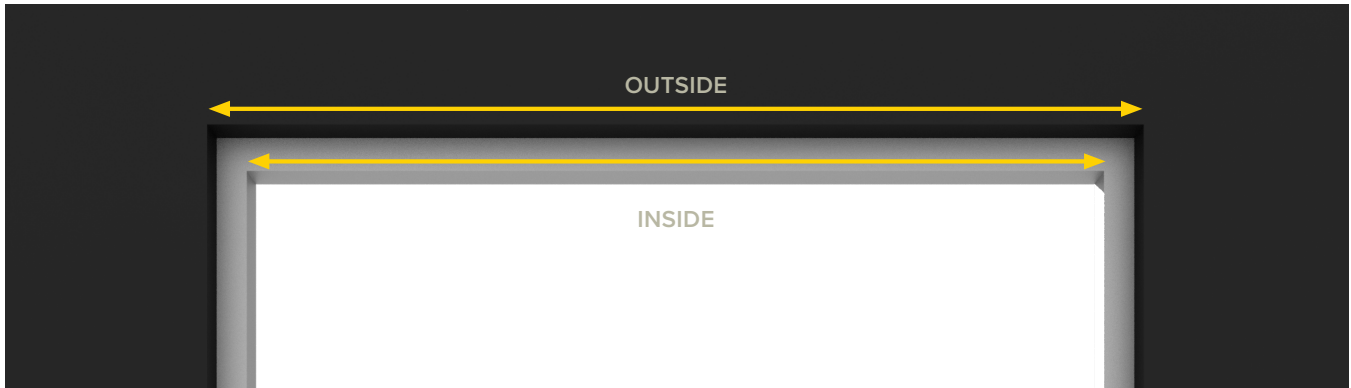

2 MOUNTING LOCATION

Place your first bracket in its mounting location and mark the screw holes. Place your brackets in its mounting location and repeat the process.

A IDLE BRACKET

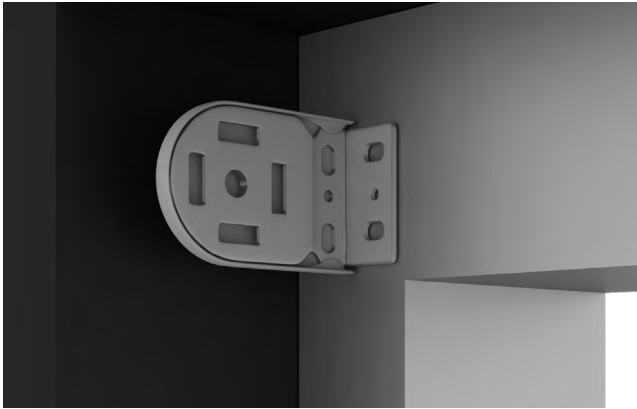

B IDLE BRACKET

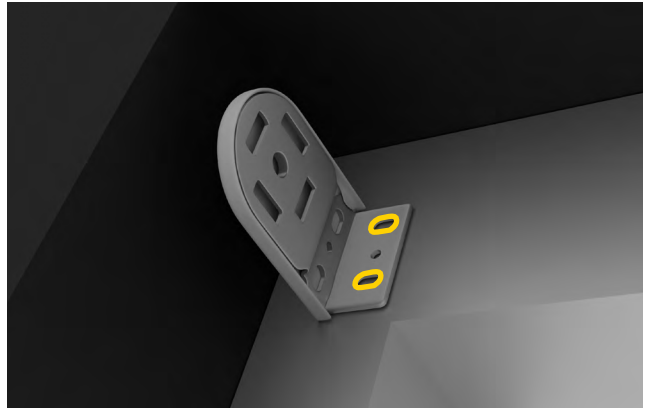

C SUPPORT BRACKET

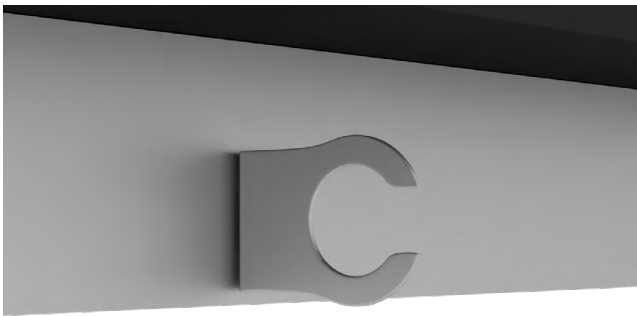

D MOTOR BRACKET

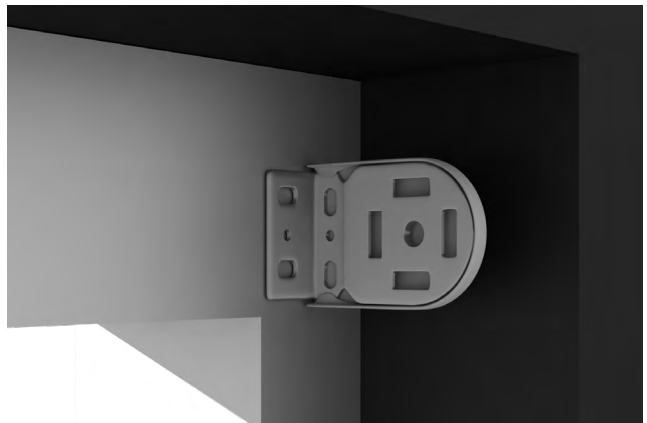

3 SCREW INSTALLATION

Next, pre-drill your screw holes using a 1/8" drill bit. Install the brackets with the provided screws using the 1/4" hex head driver.

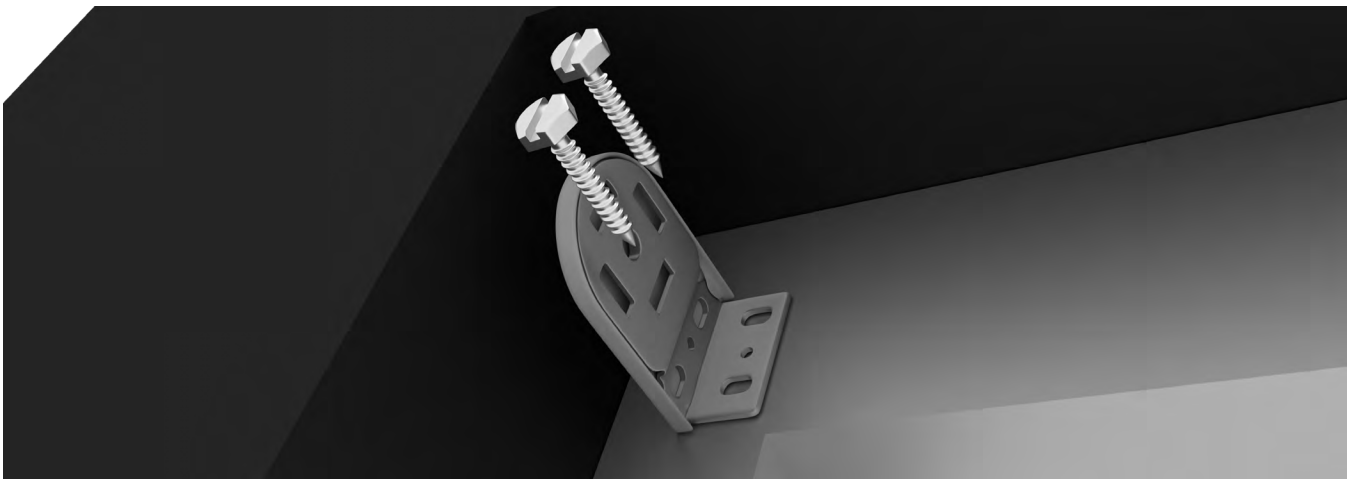

4 ALIGNMENT

Check to make sure your brackets are level and aligned.

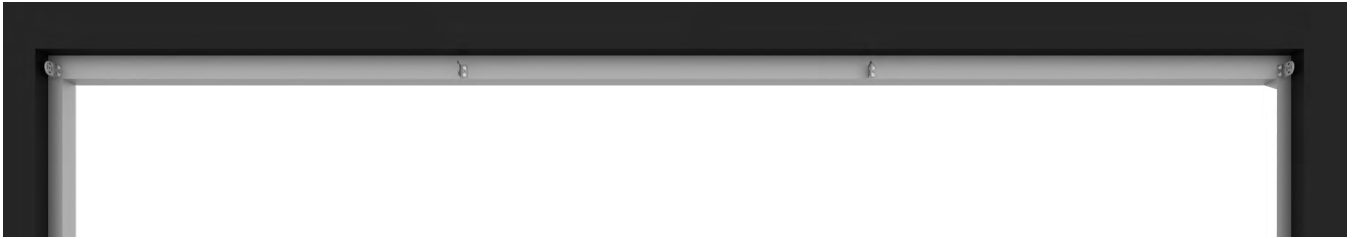

5 MOTOR END INSTALLATION

Lineup to motor bracket. Push motor into motor bracket.

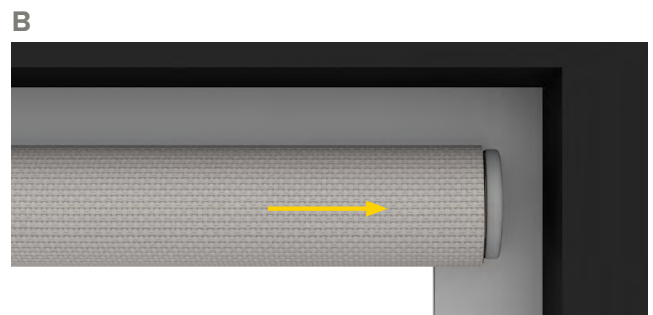

6 ADDITIONAL LINKED SHADES INSTALLATION

Go to link end of motor shade, and with holes facing away from the motor, slide bearing onto end of link pin (rotating slightly if needed **(B)**). Make sure holes are vertical as picture **C** shows and slide onto bracket. Once firmly into bracket, rotate holes 90 degrees so holes are as picture. Repeat process with additional shades.

VIDEO



* ADJUSTER TURNED





*INSERT LOCKING CLIP INTO BEARING UNTIL IT CLICKS.

NOTE: Bearing clip cannot not be removed once engaged.

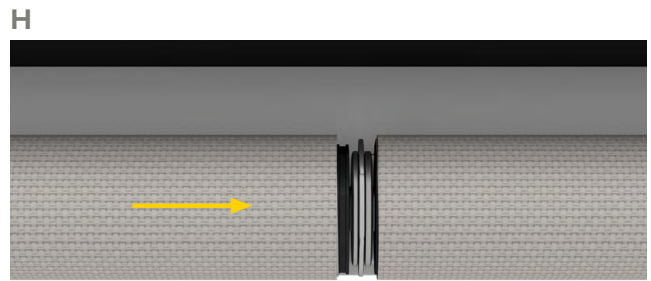
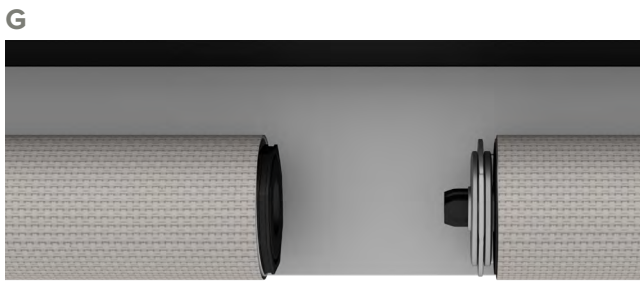

7 SHADE PIN END INSTALLATION

Depress pin end and slide onto bracket until pin engages in center hole. Press idler shaft all the way to the bracket.

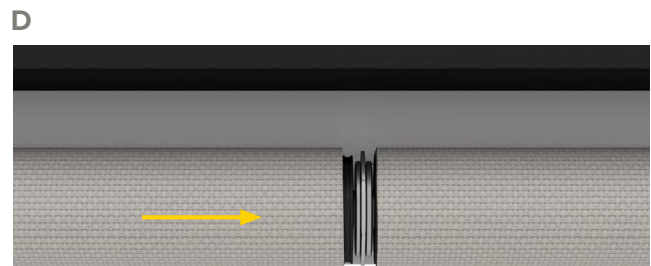
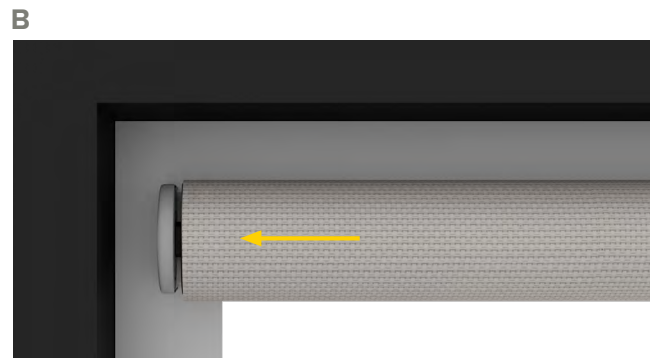

ALIGN TANG SHAFT COUPLER WITH SHAFT.

INSERT INTO SUPPORT BRACKET.

9 ADJUSTING COUPLER

NOTE:

Once link shade secured, use wheel on infinite adjuster to adjust the level of the bottom of shade of slave shade(s) until it becomes level with Motor shade. The leveling can be performed in both Up and Down direction. A spanner is available if space is too tight to get fingers around the adjusting wheel.

A

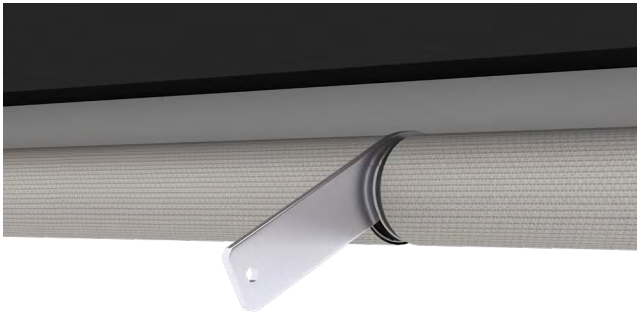

B



8 PLUG IN MOTOR

- Run motor power cord to nearest power outlet.
- Install wire tie pads and secure with zip ties to hold wire down.
- The path of the wire should be parallel with mullions and/or drop ceiling tiles ensuring the cable is neatly organized.
- Any modifications to the power cable should be done by a certified electrician to meet your city/state code requirements.



10 SHADE ADJUSTING (IF NECESSARY)

- Roll shade up and down to confirm hembar is level and material rolls up straight on center tube.
- If the hembar is not level, lower shade until you see the metal tube.
- Add layers of masking tape to the metal tube to the end that is too low until hembar is straight.
- If the material tracks to one side, lower shade until you see the metal tube.
- Add layers of masking tape to the metal tube to the end that is opposite the direction of tracking, until shade rolls up straight.

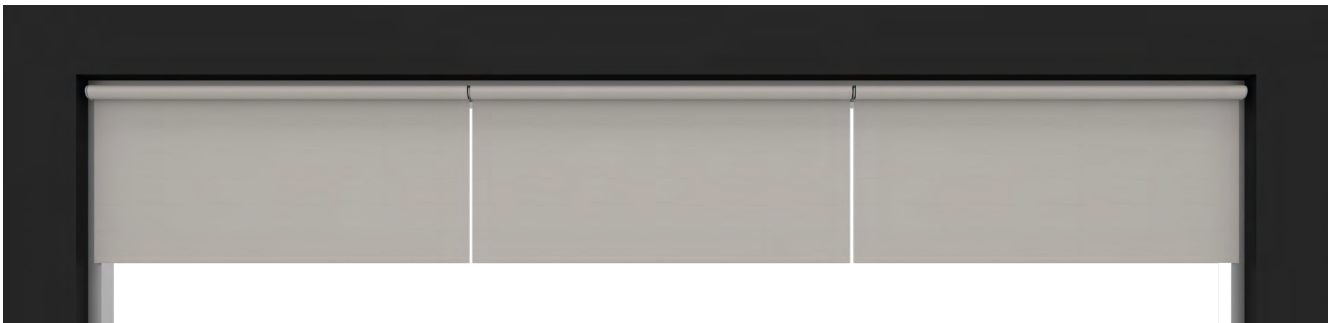

11 ADJUSTING LIMITS (IF NECESSARY)

See programming instructions based on the motor used for your application.