





RAS - Installation Instructions Chain Replacement

Hardware Included					Tools Required	
						
Clutch	Plastic Connectors or Metal Stop Ball	1/4" x 5/8" Self Tapping Screws	1/4" x 1" Wood Screws (If requested)	Self Tapping Phillips Screws for Tension Device	Phillips Head	
						Drill

1. Remove Shade from Brackets

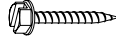
Lift the clutch (chain) side of the shade up then pull clutch out of bracket. If it "sticks" in bracket use a screw driver to gently wedge out.

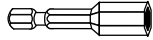
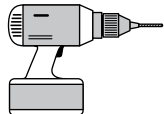
2. Remove Clutch

Place the shade on a flat stable surface. Using a small flat head screwdriver pry the clutch away from the metal tube until it is loose enough to pull out by hand.

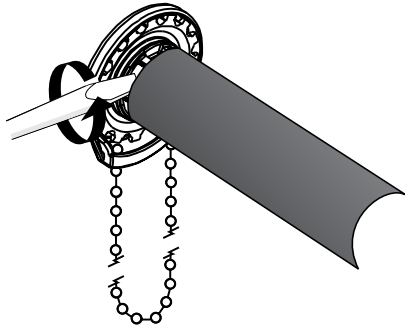

3. Roll Shade Up

By hand roll shade up until bottom rail is hanging down two inches.

4. Determine the Length of Chain

The length of chain is determined on many variables including window length and accessibility. If you need assistance contact a Roll-A-Shade Representative.

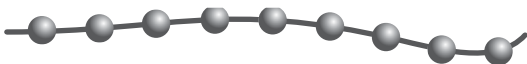

5. Insert Chain

Hold the clutch by the base. With your other hand, push small loop of chain under the chain guide.

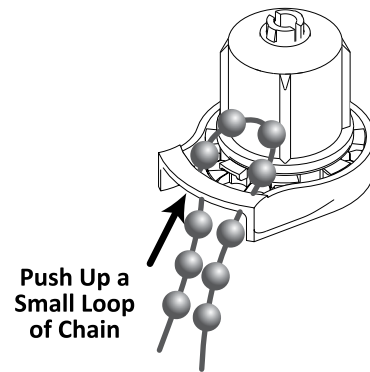

6. Trapping Chain

Firmly push the chain against the left bottom tooth edges.

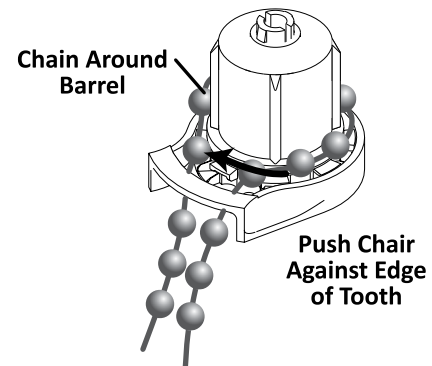

7. Rotate Chain Around Gear Teeth

After a the chain slides into first tooth groove, gently pull the chain around until the gear rotates trapping the chain in the clutch.

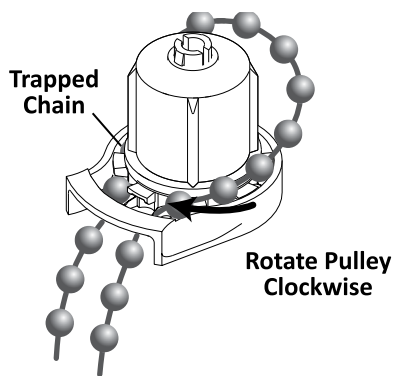

8. Remove Slack

Pull the excess chain thru the guard until all slack is removed.

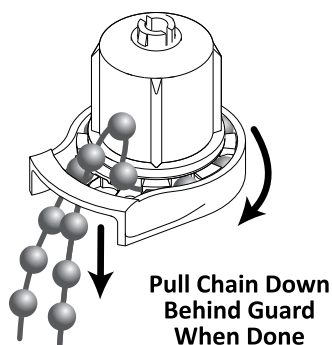

9. Setting the Right or Left Control

For a right side control, extend the chain 7" and connect the remaining chain with chain connector to the right side. For a left side control, extend the chain 7" and connect the remaining chain with chain connector to the left side.

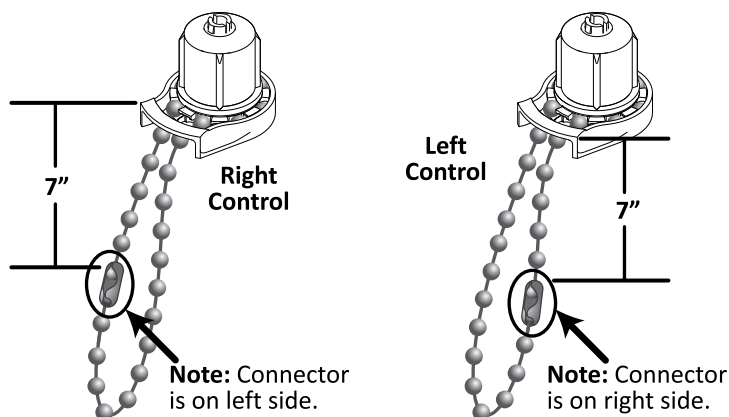

10. Thread Tension Device on Chain.

11. Insert Clutch

Insert clutch into tube making sure the chain is hanging down. The clutch will be a tight fit into the tube and may require using a rubber mallet.

DO NOT TWIST CLUTCH IN

12. Install Shade

Put the spring loaded pin into the round hole of the bracket. Keeping the pin end secured in it's bracket, insert the hook arms on the clutch straight into the two hook arm receiver holes on the bracket. Once the two hook arms are through the holes, gently pull down on the clutch until the two hook arms have locked securely to the bracket. The bottom of the clutch should always point straight down.

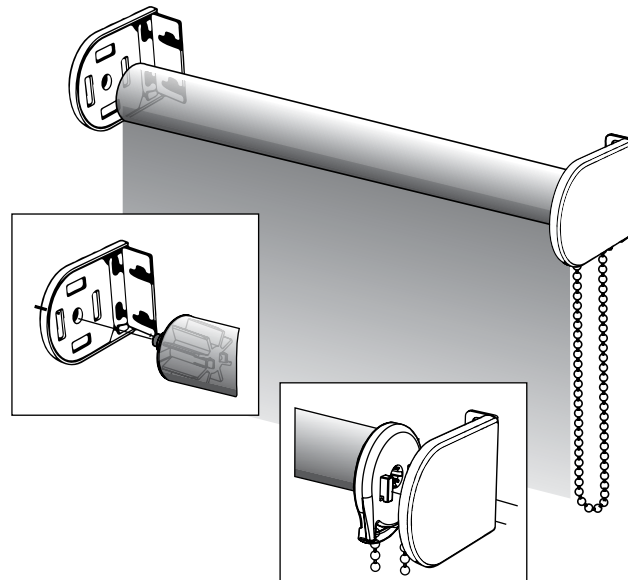

13. Install Plastic Connectors or Metal Stop Ball to Bead Chain

Pull the rear chain to lower the shade to appropriately 1/4" above sill and attach connector or stop ball to upper most bead on front chain closest to the clutch. By attaching this connector or stop ball you will set how far the shade will lower. Pull the front chain and raise the shade so the bottom rail is 5" below the shade and attach a connector or stop ball on the back chain at upper most bead.

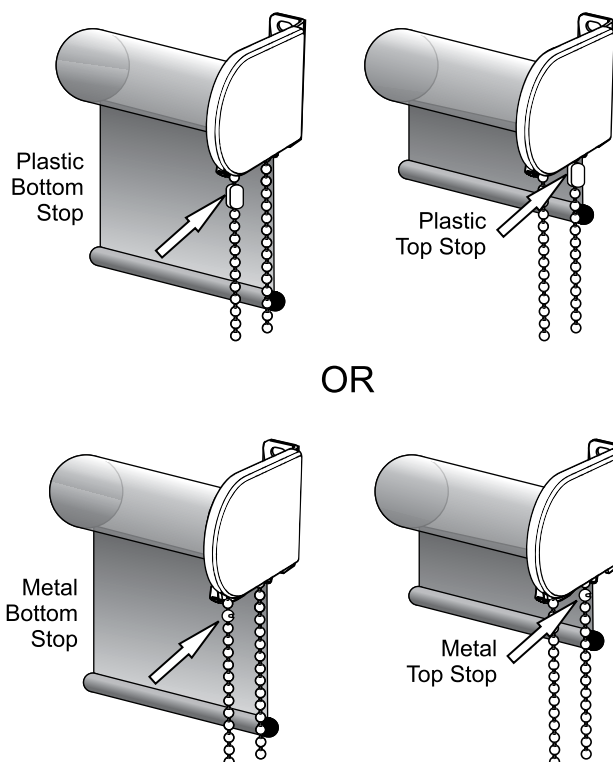

14. Install the Chain Anchor

The chain anchor is a plastic piece that is attached to the chain to secure it from possible accidents. Position the chain anchor on the window frame so that the chain anchor and chain do not interfere with raising or lowering the shade. The chain anchor should be installed without stretching or pulling down on the chain. Leave a little play through the chain anchor to allow the chain to pass freely. Do not twist or cross the bead chain. Secure the anchor with Phillips screws in both upper and lower holes.

Warning: Failure to use the tension device may cause injury or death.

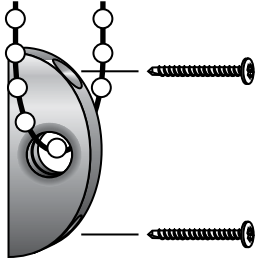

Window Blind Cord Can STRANGLE Your Child

- Children can climb furniture to reach cords
- Move cribs and other furniture away.
- Keep all cords out of children's reach.
- Attach tension device to wall or floor.
- Fasteners provided with the tension device may not be appropriate for all mounting surfaces.
- Use appropriate anchors for the mounting surface conditions.



TENSION DEVICE

INSTALLATION INSTRUCTIONS

Rollashade.com
info@rollashade.com
951.245.5077

© Copyright Roll-A-Shade® Inc. All Rights Reserved.



HARDWARE INCLUDED

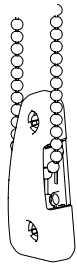

Tension Device + Chain

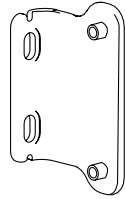

Tension Device Bracket



Short Screws



Screws

TOOLS REQUIRED

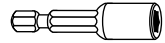

3/8" Hex Head

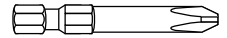

Phillips Head



1/8" Drill Bit

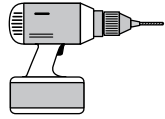

Drill

INSIDE OR OUTSIDE APPLICATION

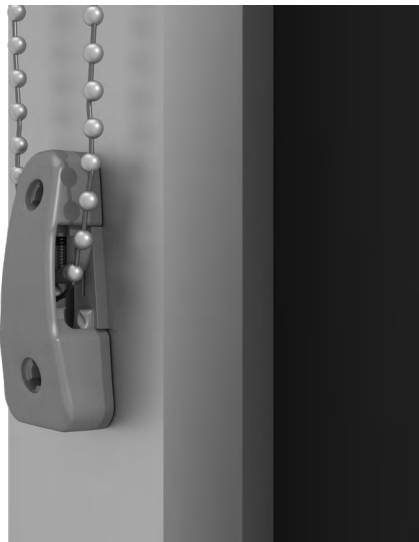
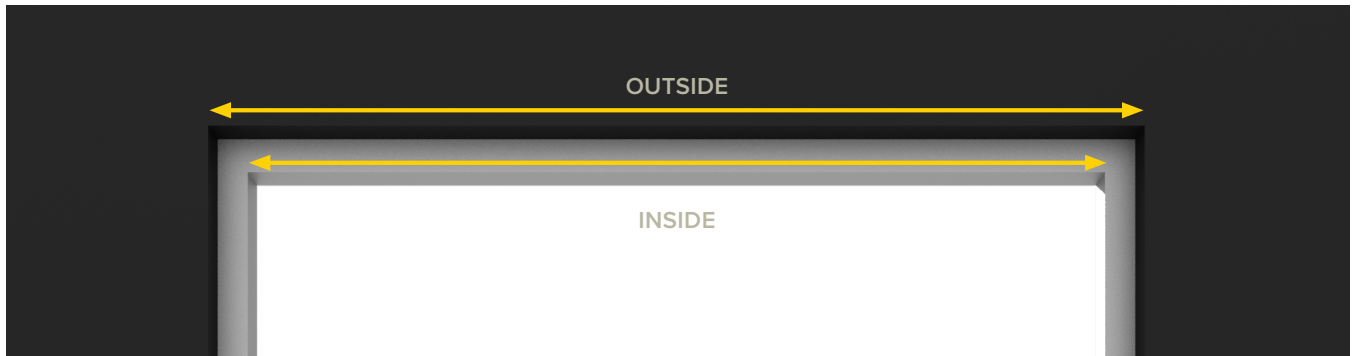

INSIDE



OUTSIDE

INSIDE MOUNT & TENSION DEVICE INSTALLATION

Pull the Chainhold down until the chain is fully tensioned (plunger will be fully raised). Screw device into wall.

A

KEEP
TENSION

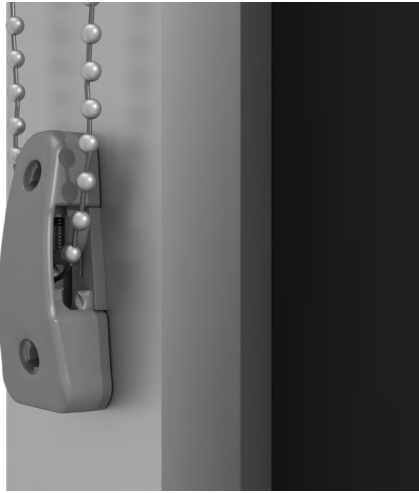

B



C

SECURE
TENSION
DEVICE



NOTE: Please make sure shade operates smoothly.

OUTSIDE MOUNT & TENSION DEVICE INSTALLATION

With provided screws, install bracket first with large screws (use Chainhold marked screw hole locations as reference). Pull the Chainhold down until the chain is fully tensioned (plunger will be fully raised). Install Chainhold into bracket with small screws.

A

PULL CHAIN
DOWN &
MARK
LOCATION

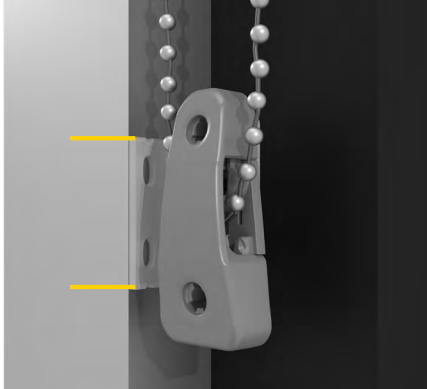

B

REMOVE
TENSION
DEVICE
& DRILL

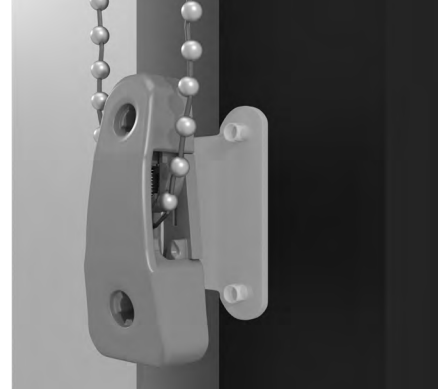

C

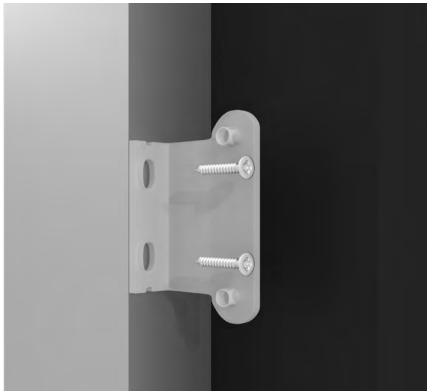

D

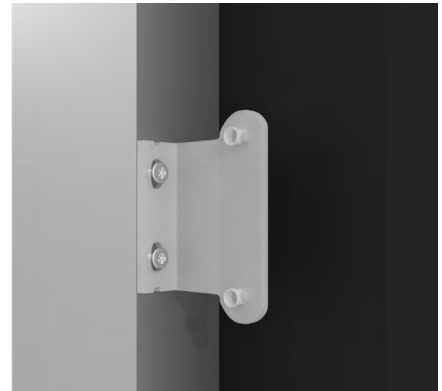

E

PLACE
TENSION
DEVICE
ON
BRACKET



F

SECURE
TENSION
DEVICE

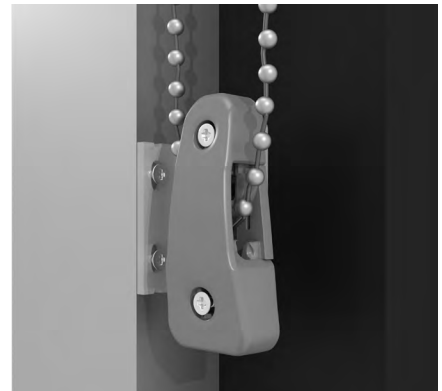

NOTE: Please make sure shade operates smoothly.