

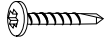

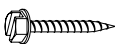

RAS - Installation Instructions Contract Plus+ Shade 4-6" Pocket Manual

Hardware Included					Tools Required	
						
Self Tapping Screws for Aluminum	Self Tapping Phillips Screws for Tension Device	Wood Screws (If requested)	Plastic Connectors	Metal Stop Balls	Drill	3/8" Drill Bit Phillips Head

1. Install Cassette Box

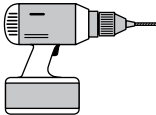
Pre-drill mounting holes in top or back of cassette box. Attach the cassette box to the window frame, window molding, or ceiling per diagram. Two screws must be installed in each end as shown. Additional screws should be used in the center if the cassette box is over 3 ft wide.

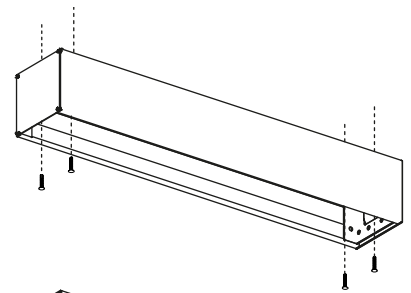

2. Install Shade

Insert the spring loaded end of the shade into the round hole of the bracket. Next, on the other side of the shade, insert the hook arms of the clutch straight into the two hook arm receiver holes of the bracket. Gently pull down the clutch until the two hook arms have locked securely to the bracket. The bottom of the clutch should always point straight down.

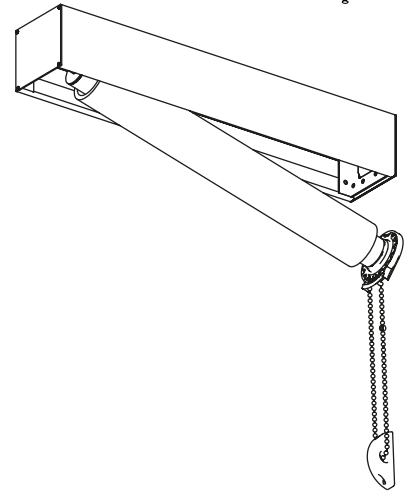

3. Shade Adjustment (If Necessary)

Roll shade up and down to confirm bottom rail is level and material rolls up straight on center tube. If the bottom rail is not level, lower shade until you see the metal tube. Add layers of masking tape to the metal tube to the end that is too low until bottom rail is straight. If the material tracks to one side, lower shade until you see the metal tube. Add layers of masking tape



4. Install Cassette Box Bottom Closure

Attach the bottom enclosure by hanging it on the front box hanger. Please note, the bottom closure should not interfere with the operating chain.

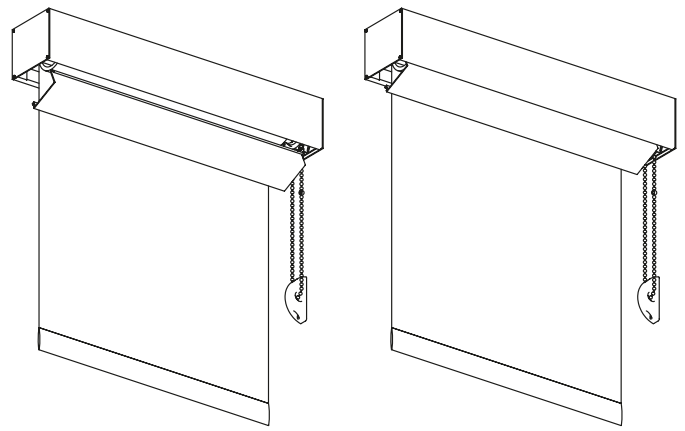

5. Install Chain Anchor

The chain anchor is a plastic piece that is attached to the chain to secure it from possible accidents. Position the chain anchor on the window frame so that the chain anchor and chain do not interfere with raising or lowering the shade. The chain anchor should be installed without stretching or pulling down on the chain. Leave a little play through the chain anchor to allow the chain to pass freely. Do not twist or cross the bead chain. Secure the anchor with Phillips screws in both upper and lower holes.

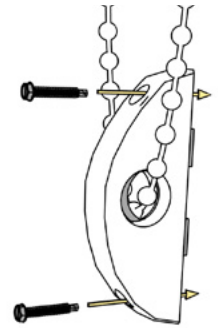

Warning: Failure to use this device may cause injury or death

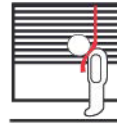

Young children can STRANGLE in cord and bead chain loops. They can also wrap cords around their necks and STRANGLE.

- Always keep cords and bead chains out of children's reach.
- Move cribs, playpens, and other furniture away from cords and bead chains. Children can climb furniture to get to cords.
- Attach tension device to wall or floor. This can prevent children from pulling cords and bead chains around their necks. Fasteners provided with the tension device may not be appropriate for all mounting surfaces. Use appropriate anchors for the mounting surface conditions.



TENSION DEVICE

INSTALLATION INSTRUCTIONS

Rollashade.com
info@rollashade.com
951.245.5077

© Copyright Roll A Shade® Inc. All Rights Reserved.

© ROLL A SHADE

HARDWARE INCLUDED

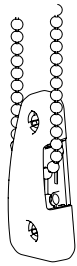

Tension Device + Chain

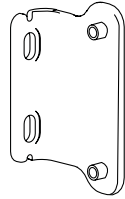

Tension Device Bracket



Short Screws



Screws

TOOLS REQUIRED

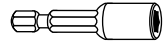

3/8" Hex Head



Phillips Head



1/8" Drill Bit

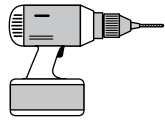

Drill

INSIDE OR OUTSIDE APPLICATION

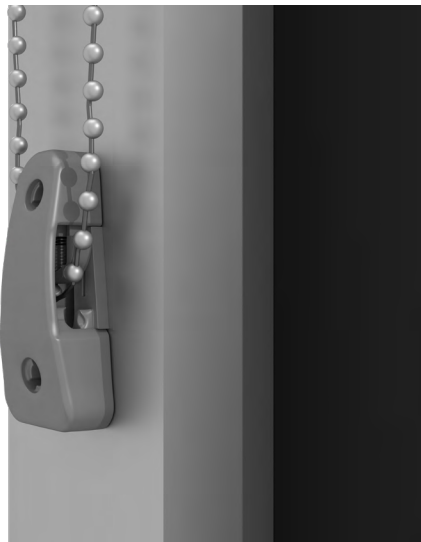
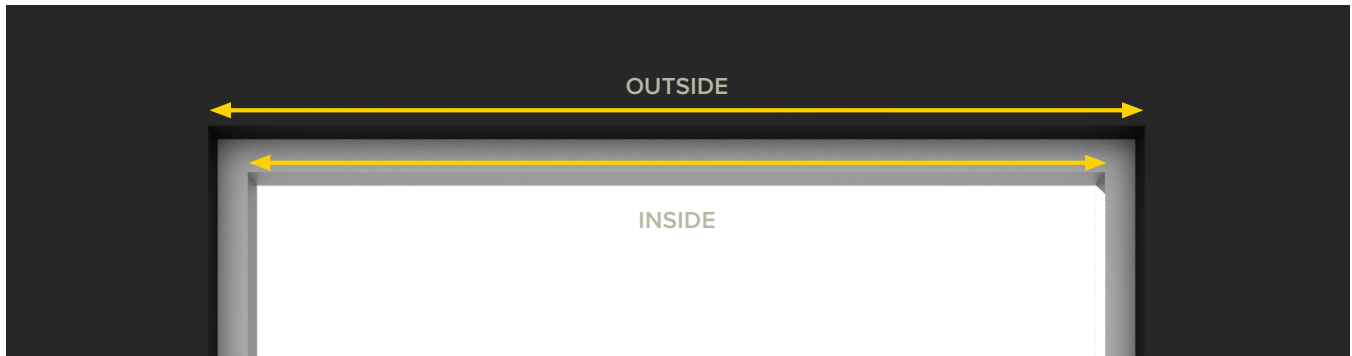

INSIDE



OUTSIDE

INSIDE MOUNT & TENSION DEVICE INSTALLATION

Pull the Chainhold down until the chain is fully tensioned (plunger will be fully raised). Screw device into wall.

A

KEEP
TENSION



B



C

SECURE
TENSION
DEVICE



NOTE: Please make sure shade operates smoothly.

OUTSIDE MOUNT & TENSION DEVICE INSTALLATION

With provided screws, install bracket first with large screws (use Chainhold marked screw hole locations as reference). Pull the Chainhold down until the chain is fully tensioned (plunger will be fully raised). Install Chainhold into bracket with small screws.

A

PULL CHAIN
DOWN &
MARK
LOCATION

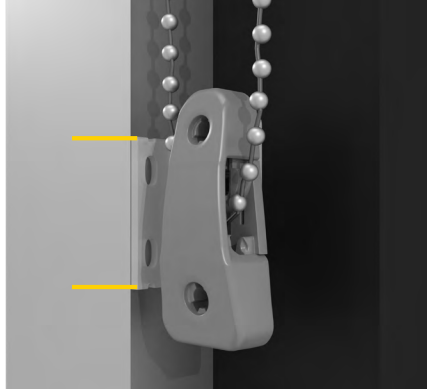

B

REMOVE
TENSION
DEVICE
& DRILL

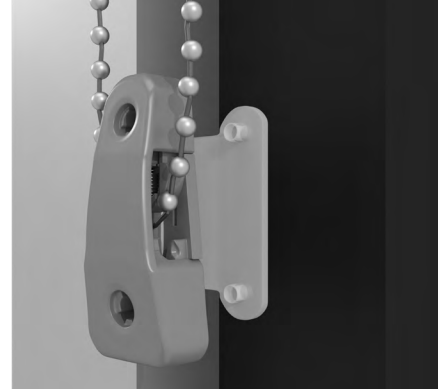

C

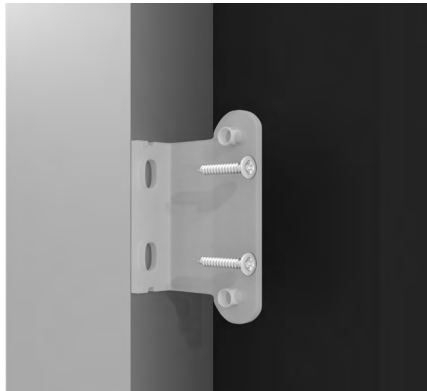

D

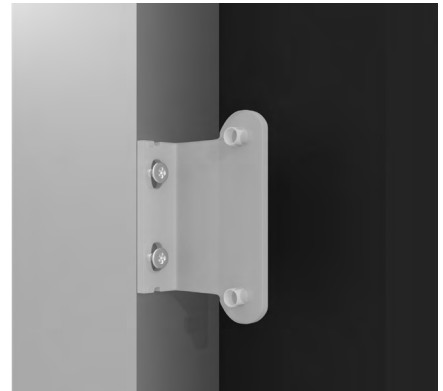

E

PLACE
TENSION
DEVICE
ON
BRACKET



F

SECURE
TENSION
DEVICE

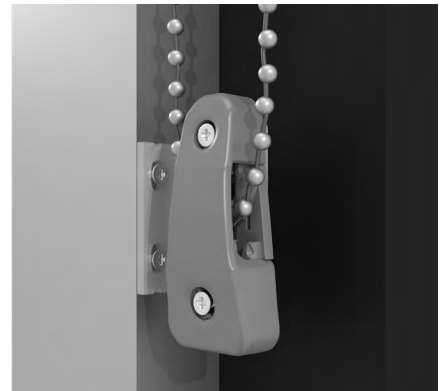

NOTE: Please make sure shade operates smoothly.