

Cassette Installation Instructions

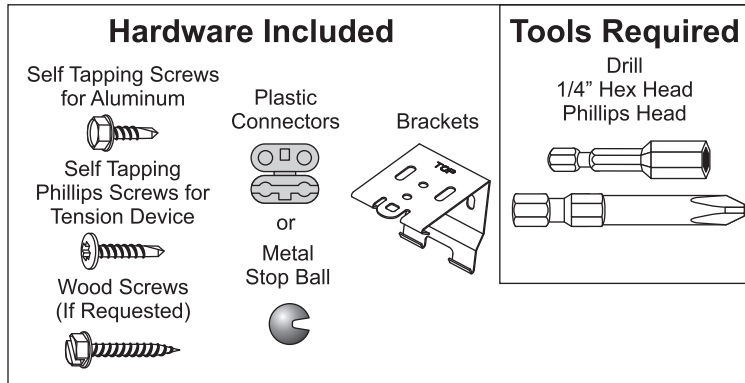

1. Release Tab and Bottom Hooks

Make sure the release tab is always mounted on the top and the bottom hooks are on the bottom.

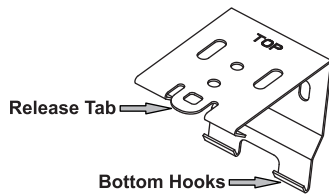

2. Install Bracket

Attach the brackets to the window frame, window molding, wall or ceiling with a minimum .25" gap to any perpendicular surface per diagrams. Two screws must be installed in each bracket as shown.

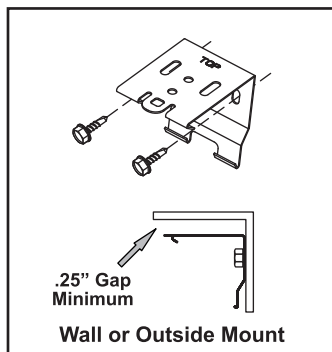

OR

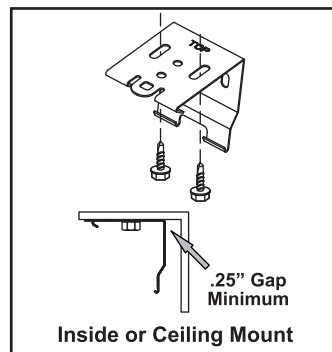

3. Mount the Headrail

Position the headrail with the back panel (A) resting on both bottom hooks of all brackets. Push the front of the headrail firmly upwards toward the window until the groove at the top of the headrail snaps into place, (B) as shown.

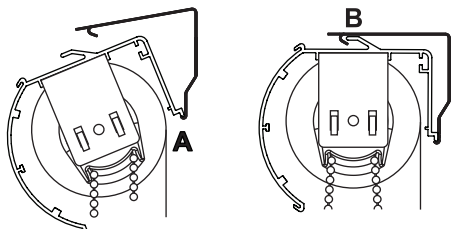

4. Shade Adjusting (If Necessary)

Roll shade up and down to confirm bottom rail is level and material rolls up straight on center tube. If the bottom rail is not level, lower shade until you see the metal tube. Add layers of masking tape to the metal tube to the end that is too low until bottom rail is straight. If the material tracks to one side, lower shade until you see the metal tube. Add layers of masking tape to the metal tube to the end that is opposite the direction of tracking, until shade rolls up straight.

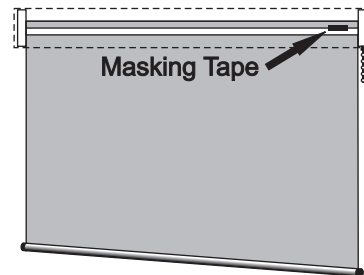

5. Install Plastic Connectors or Metal Stop Ball to Bead Chain

Pull the rear chain to lower the shade to appropriately 1/4" above sill and attach connector or stop ball to upper most bead on front chain closest to the clutch. By attaching this connector or stop ball you will set how far the shade will lower. Pull the front chain and raise the shade so the bottom rail is 5" below the shade and attach a connector or stop ball on the back chain at upper most bead.

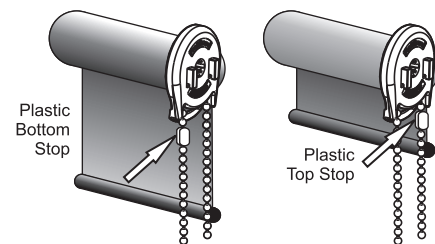

OR

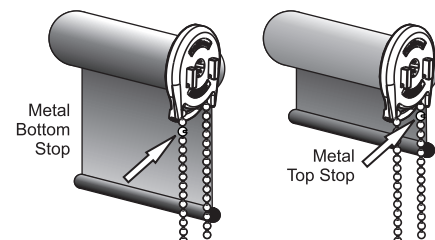

6. Install the Chain Anchor

The chain anchor is a plastic piece that is attached to the chain to secure it from possible accidents. Position the chain anchor on the window frame so that the chain anchor and chain do not interfere with raising or lowering the shade. The chain anchor should be installed without stretching or pulling down on the chain. Leave a little play through the chain anchor to allow the chain to pass freely. Do not twist or cross the bead chain. Secure the anchor with Phillips screws in both upper and lower holes.

Warning: Failure to use the tension device may cause injury or death.

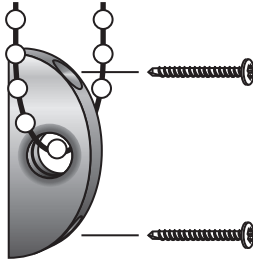

 **WARNING**

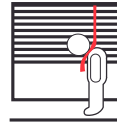

Window Blind Cord Can STRANGLE Your Child

- Children can climb furniture to reach cords
- Move cribs and other furniture away.
- Keep all cords out of children's reach.
- Attach tension device to wall or floor.
- Fasteners provided with the tension device may not be appropriate for all mounting surfaces.
- Use appropriate anchors for the mounting surface conditions.



TENSION DEVICE

INSTALLATION INSTRUCTIONS

Rollashade.com
info@rollashade.com
951.245.5077

© Copyright Roll A Shade® Inc. All Rights Reserved.

© ROLL A SHADE

HARDWARE INCLUDED

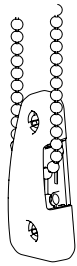

Tension Device + Chain

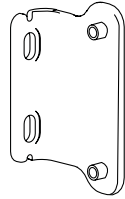

Tension Device Bracket



Short Screws



Screws

TOOLS REQUIRED

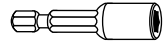

3/8" Hex Head



Phillips Head



1/8" Drill Bit

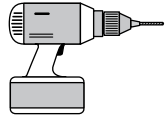

Drill

INSIDE OR OUTSIDE APPLICATION

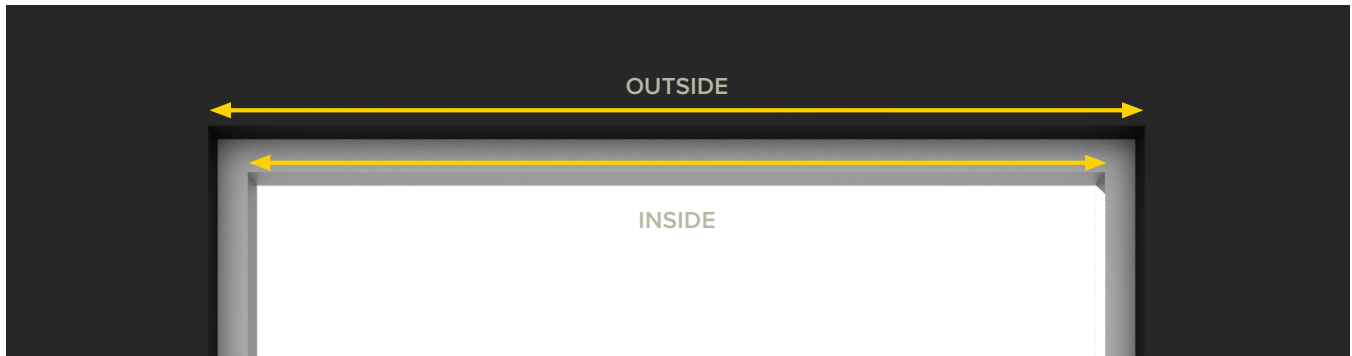

INSIDE



OUTSIDE

INSIDE MOUNT & TENSION DEVICE INSTALLATION

Pull the Chainhold down until the chain is fully tensioned (plunger will be fully raised). Screw device into wall.

A

KEEP
TENSION



B



C

SECURE
TENSION
DEVICE



NOTE: Please make sure shade operates smoothly.

OUTSIDE MOUNT & TENSION DEVICE INSTALLATION

With provided screws, install bracket first with large screws (use Chainhold marked screw hole locations as reference). Pull the Chainhold down until the chain is fully tensioned (plunger will be fully raised). Install Chainhold into bracket with small screws.

A

PULL CHAIN
DOWN &
MARK
LOCATION

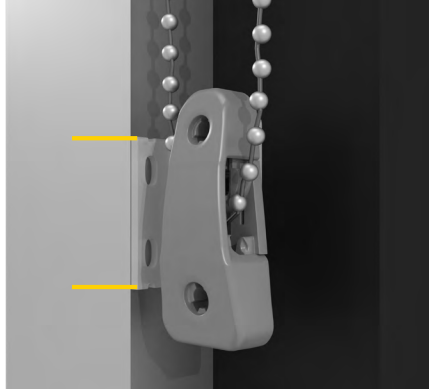

B

REMOVE
TENSION
DEVICE
& DRILL

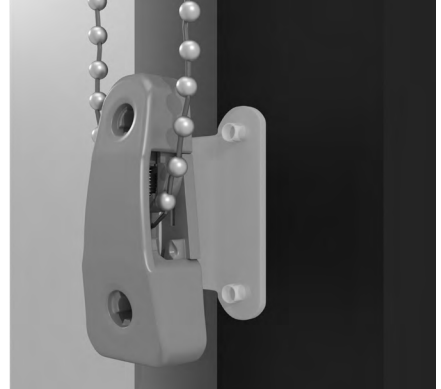

C

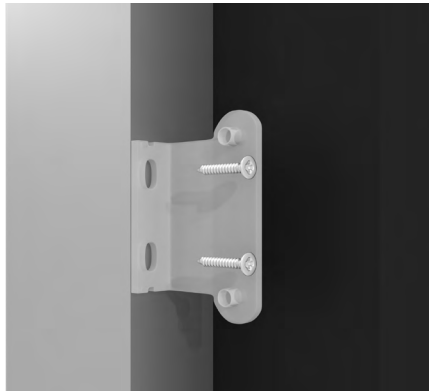

D

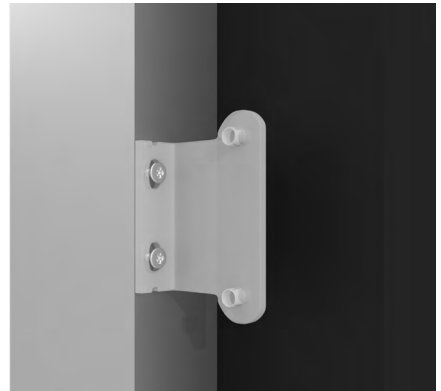

E

PLACE
TENSION
DEVICE ON
BRACKET



F

SECURE
TENSION
DEVICE

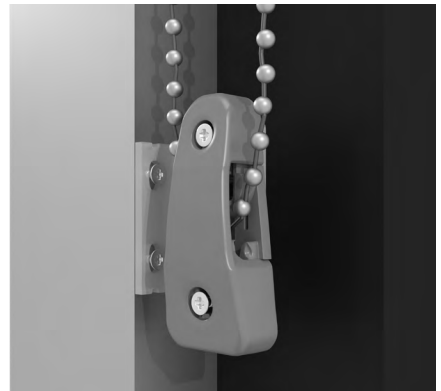

NOTE: Please make sure shade operates smoothly.