









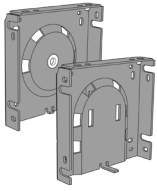

## RAS - Installation Instructions Plus+ Shade 4" Bottom Fascia Manual

Hardware Included						Tools Required	
							
Self Tapping Screws for Aluminum	Wood Screws (If requested)	Self Tapping Phillips Screws for Tension Device	Drywall Anchors	Brackets	Bracket Cover (Optional)	Drill	1/4" Hex Head
							
			Metal Stop Ball		Fascia		Phillips Head

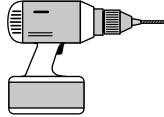
### 1. Install Bracket

Attach the brackets to the window frame, molding, wall or ceiling. Brackets are directional oriented, control side has indents for clutch and in end bracket has a small hole for pin end. (picture shows a right control install). Indents in sides can be used for easier access when screwing from the side. Two screws must be installed in each bracket.

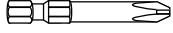
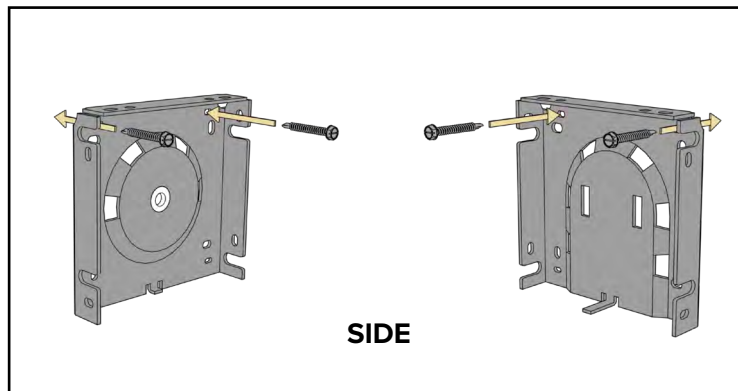
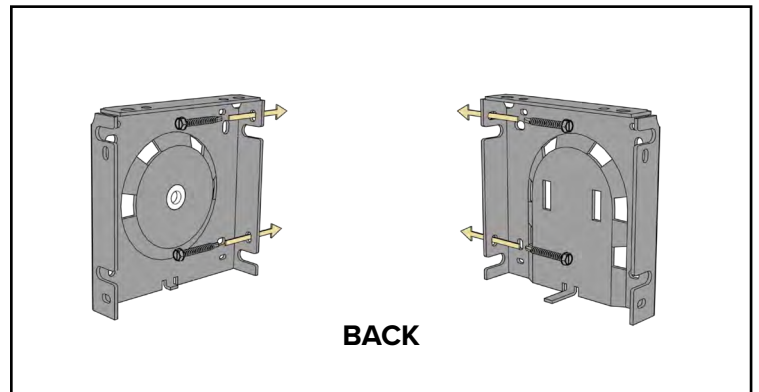
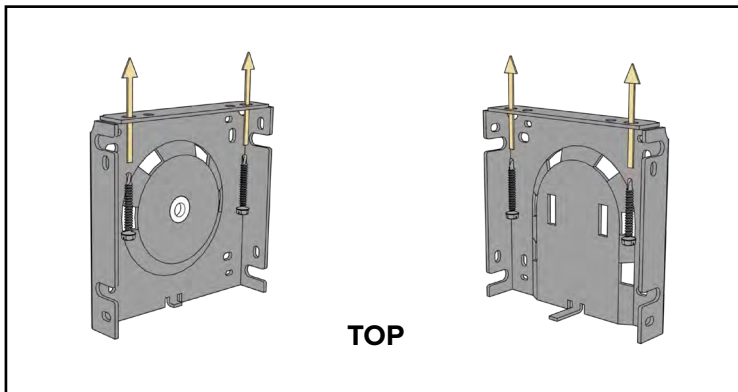

### 2. Install Shade

Push the clutch straight into the indents in the bracket. The bottom of the clutch should always point straight down (Fig A). Next, using your finger or a flat end screwdriver, press in the pin end, keeping it compressed (Fig B) while maneuvering it into the hole in the pin end bracket (Fig C).

Note: If you need to remove the shade, compress the pin end by using a flat end screwdriver and pull the shade down and out.

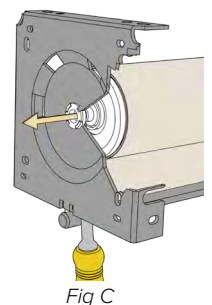
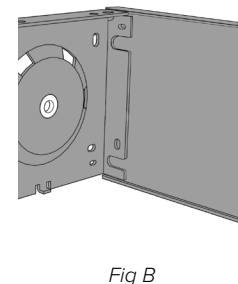
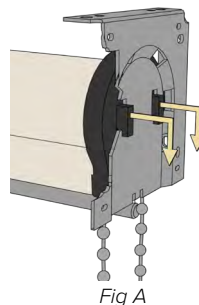

### 3. Shade Adjustment (If Necessary)

Roll shade up and down to confirm bottom rail is level and material rolls up straight on center tube. If the bottom rail is not level, lower shade until metal tube is visible. Add layers of masking tape to the metal tube to the end that is too low until bottom of rail is straight. If the material tracks to one side, lower shade until metal tube is visible. Add layers of masking tape to the metal tube to the end that is opposite the direction of tracking, until shade rolls up straight.

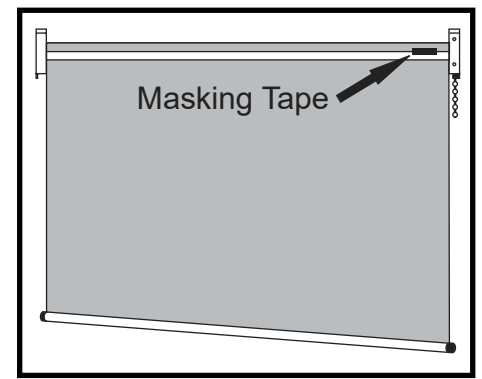

### 4. Installing the Fascia

Hook fascia to the top of the bracket and gently press fascia down to snap into bracket.

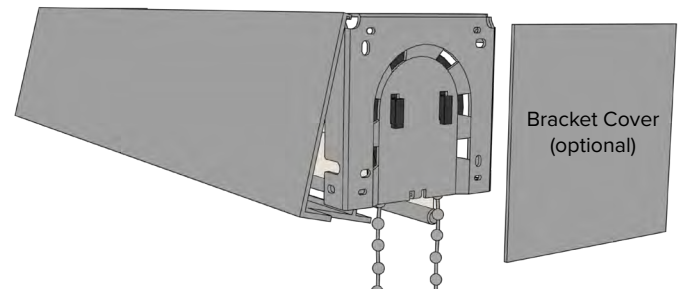

### 5. Installing Metal Stop Balls to Bead Chain

Pull the rear chain to lower the shade to appropriately 1/4" above sill and attach connector or stop ball to upper most bead on front chain closest to the clutch. By attaching this connector or stop ball you will set how far the shade will lower. Pull the front chain and raise the shade so the bottom rail is 5" below the shade and attach a connector or stop ball on the back chain at upper most bead.

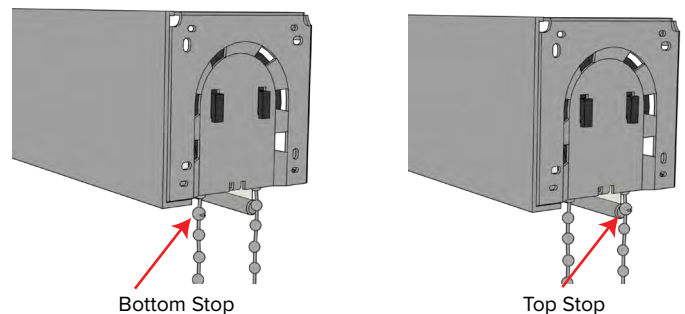

### 6. Install the Chain Anchor

The chain anchor is a plastic piece that is attached to the chain to secure it from possible accidents. Position the chain anchor on the window frame so that the chain anchor and chain do not interfere with raising or lowering the shade. The chain anchor should be installed without stretching or pulling down on the chain. Leave a little play through the chain anchor to allow the chain to pass freely. Do not twist or cross the bead chain. Secure the anchor with Phillips screws in both upper and lower holes.

**Warning: Failure to use this device may cause injury or death**

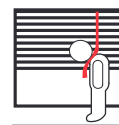
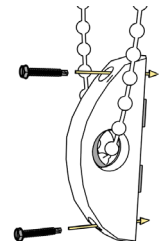

Window Blind Cord Can STRANGLE Your Child

- Children can climb furniture to reach cords
- Move cribs and other furniture away.
- Keep all cords out of children's reach.
- Attach tension device to wall or floor.
- Fasteners provided with the tension device may not be appropriate for all mounting surfaces.
- Use appropriate anchors for the mounting surface conditions.



# TENSION DEVICE

## INSTALLATION INSTRUCTIONS

Rollashade.com  
info@rollashade.com  
951.245.5077

© Copyright Roll A Shade® Inc. All Rights Reserved.

© ROLL A SHADE

HARDWARE INCLUDED

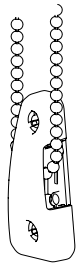

Tension Device + Chain

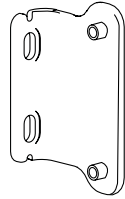

Tension Device Bracket



Short Screws



Screws

TOOLS REQUIRED

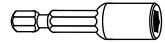

3/8" Hex Head



Phillips Head



1/8" Drill Bit

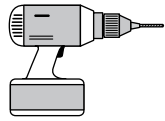

Drill

INSIDE OR OUTSIDE APPLICATION

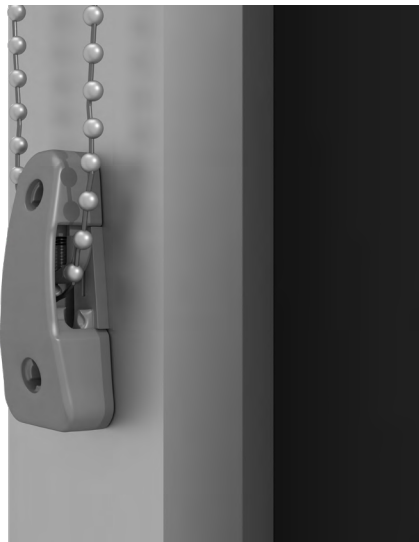
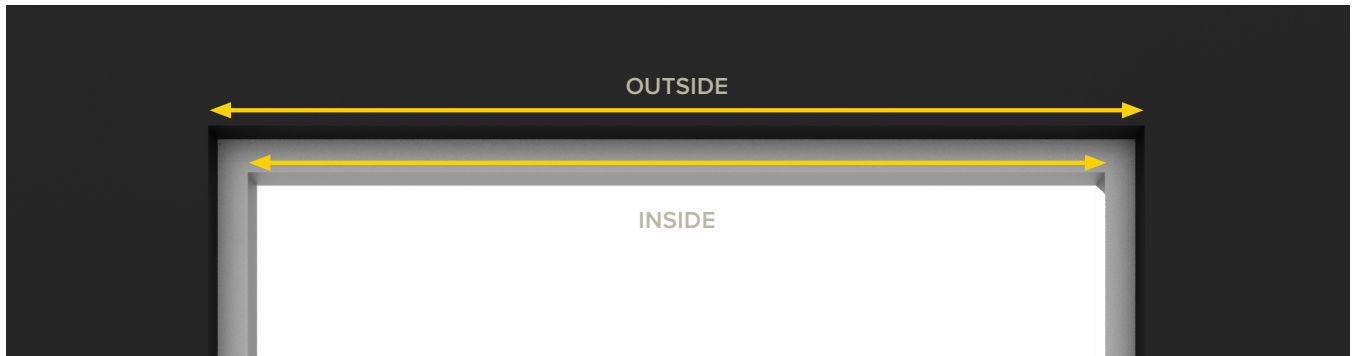

INSIDE



OUTSIDE

## INSIDE MOUNT & TENSION DEVICE INSTALLATION

Pull the Chainhold down until the chain is fully tensioned (plunger will be fully raised). Screw device into wall.

A

KEEP  
TENSION



B



C

SECURE  
TENSION  
DEVICE



**NOTE:** Please make sure shade operates smoothly.

## OUTSIDE MOUNT & TENSION DEVICE INSTALLATION

With provided screws, install bracket first with large screws (use Chainhold marked screw hole locations as reference). Pull the Chainhold down until the chain is fully tensioned (plunger will be fully raised). Install Chainhold into bracket with small screws.

A

PULL CHAIN  
DOWN &  
MARK  
LOCATION

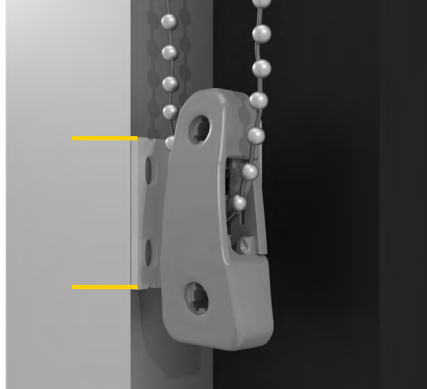

B

REMOVE  
TENSION  
DEVICE  
& DRILL

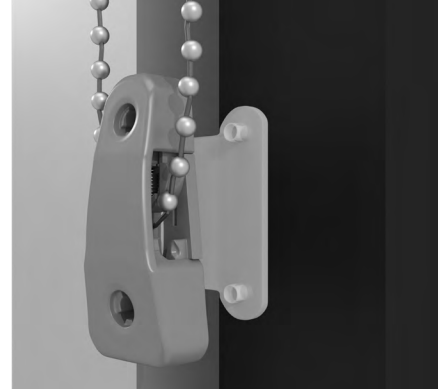

C

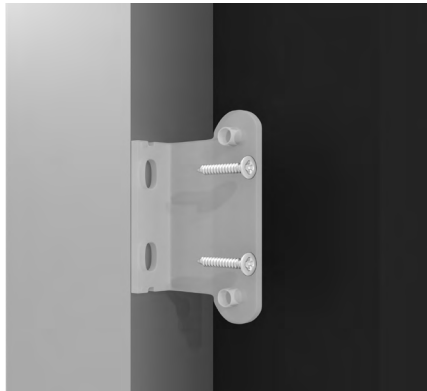

D

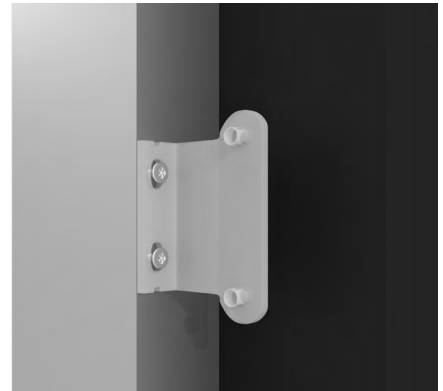

E

PLACE  
TENSION  
DEVICE ON  
BRACKET



F

SECURE  
TENSION  
DEVICE

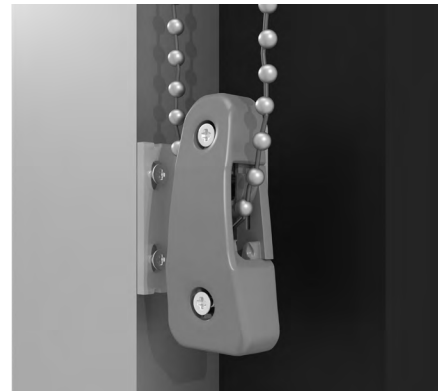

**NOTE:** Please make sure shade operates smoothly.