



PLUS⁺ SHADE OPEN ROLL MANUAL

INSTALLATION INSTRUCTIONS

Rollashade.com
info@rollashade.com
951.245.5077

© Copyright Roll A Shade® Inc. All Rights Reserved.

 ROLL A SHADE

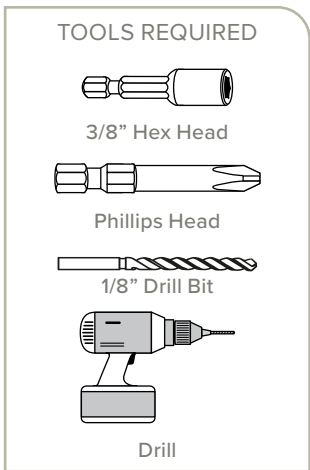
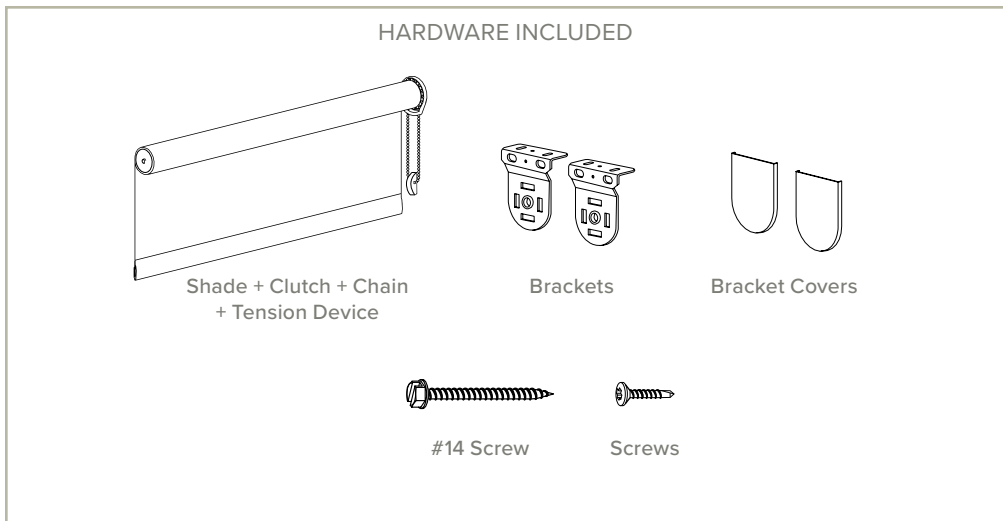

1 INSIDE OR OUTSIDE APPLICATION

****NOTE: ALL SHADES MAY BE PRE-PROGRAMMED TO SENSORS, REMOTES, AND/OR WALL SWITCHES UPON ARRIVAL****

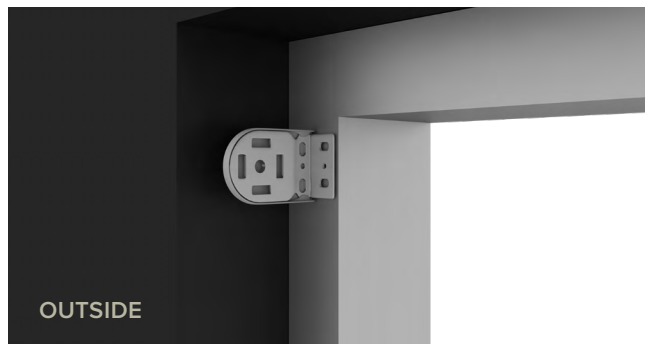
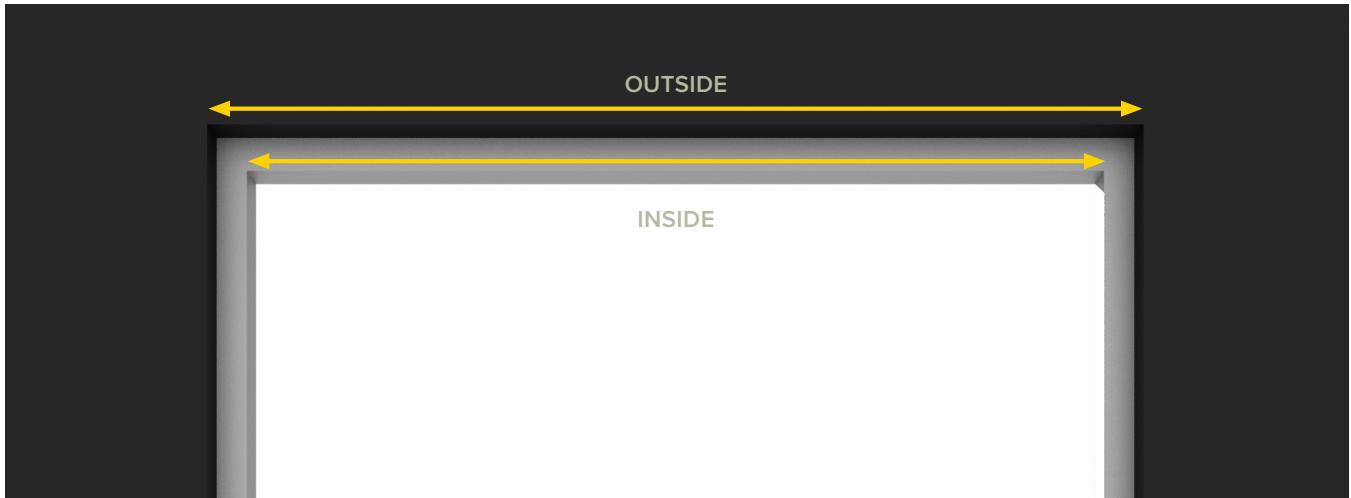

2 MOUNTING LOCATION

Place your first bracket in its mounting location and mark the screw holes. Place your second bracket in its mounting location and repeat the process.

A.



B.

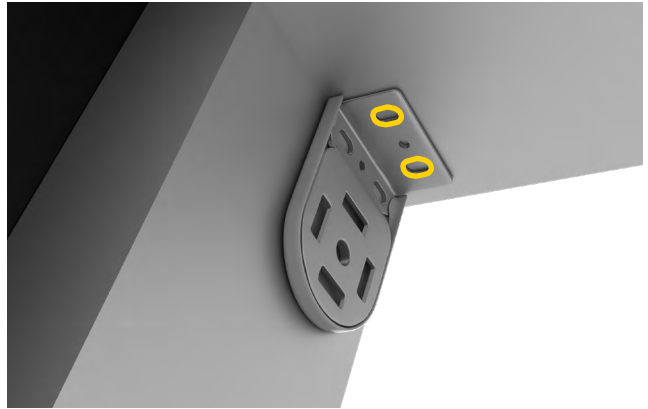

C.



3 SCREW INSTALLATION

Next, pre-drill your screw holes using a 1/8" drill bit. Install the brackets with the provided screws using the 1/4" hex head driver.

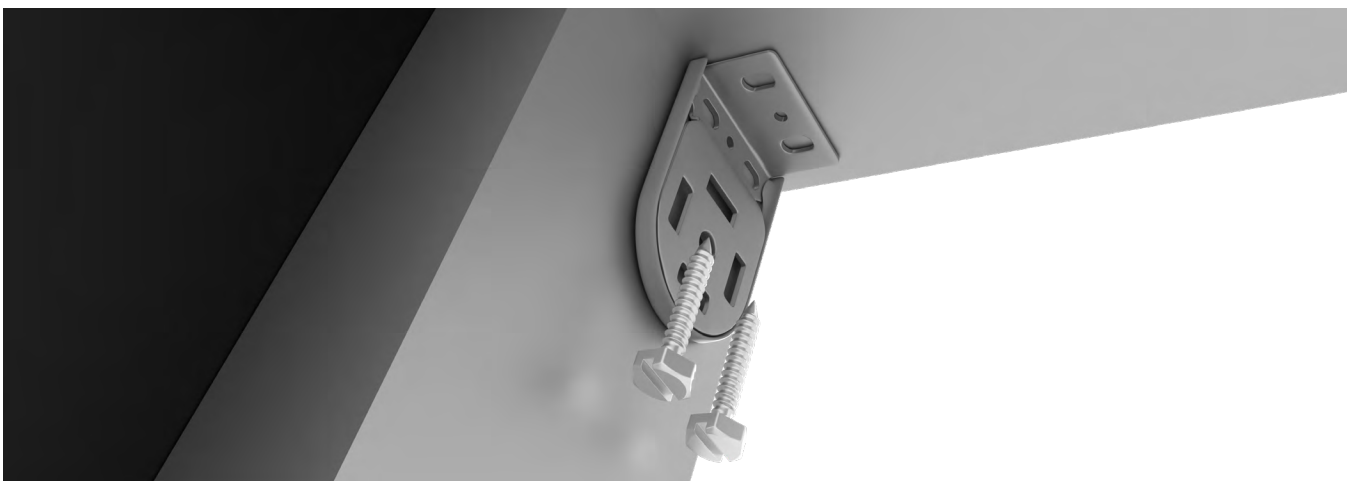

4 ALIGNMENT

Check to make sure your brackets are level and aligned.

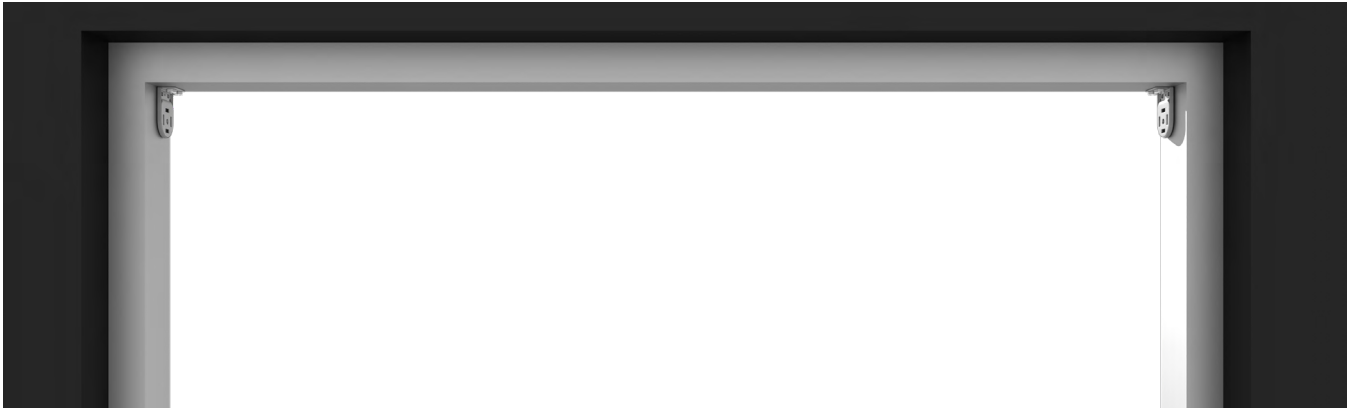

5 SHADE PIN END INSTALLATION

Depress pin end and slide onto bracket until pin engages in center hole. Press idler shaft all the way to the bracket.

A

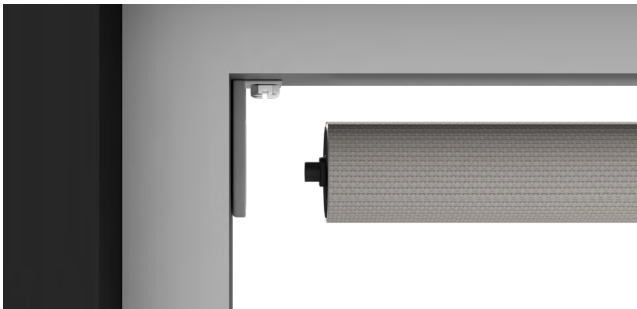

B

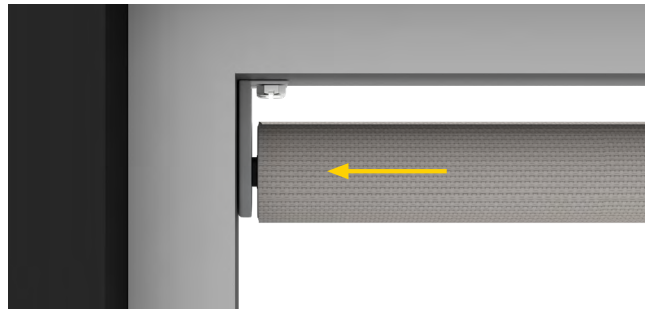

5 CLUTCH END & TENSION DEVICE INSTALLATION

Lineup to clutch bracket. Push clutch into clutch bracket. Install tension device.

A.



B.



C.

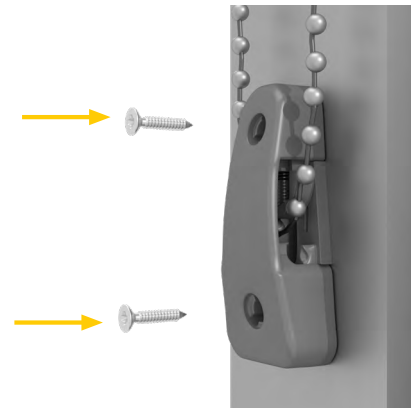

11 COMPLETED INSTALLATION

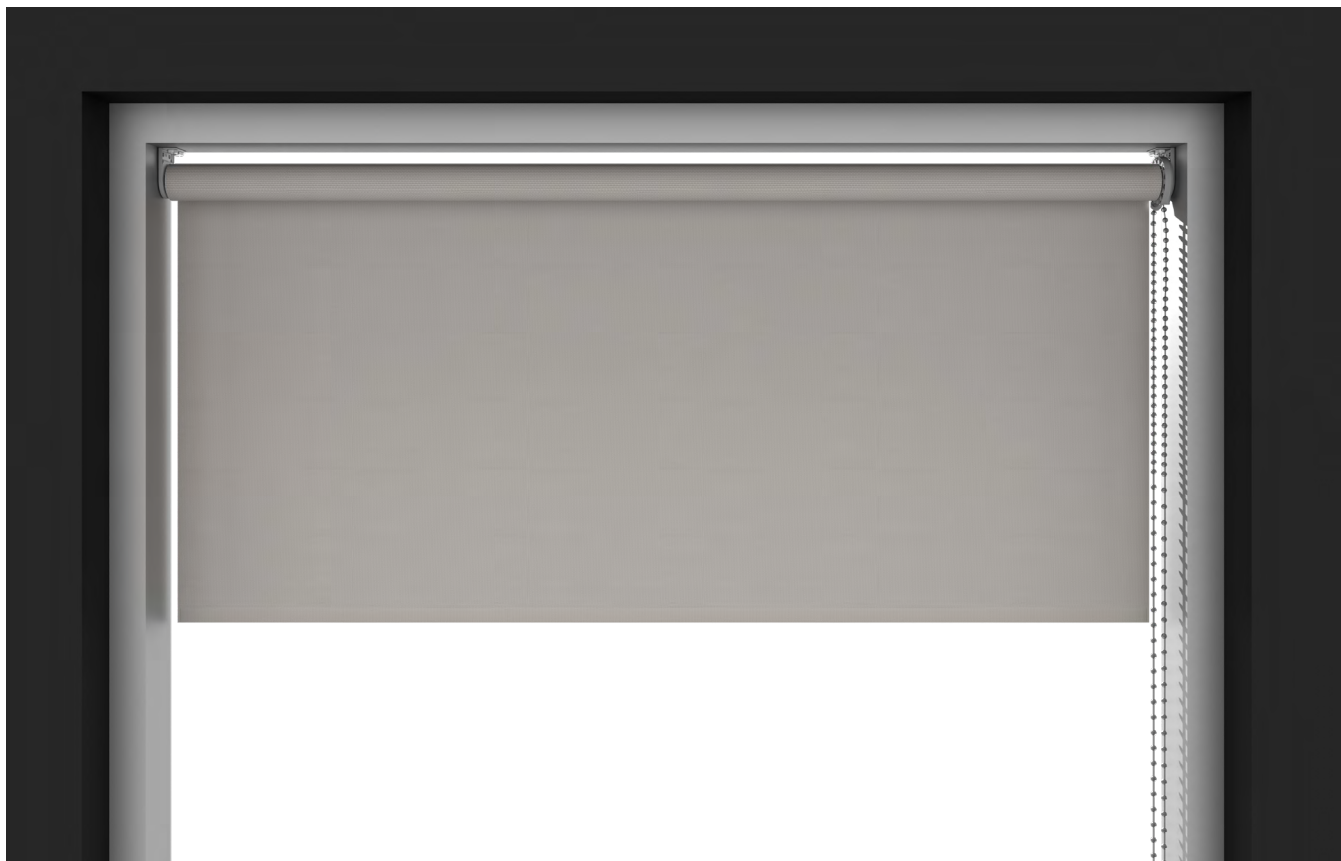



TENSION DEVICE

INSTALLATION INSTRUCTIONS

Rollashade.com
info@rollashade.com
951.245.5077

© Copyright Roll A Shade® Inc. All Rights Reserved.

© ROLL A SHADE

HARDWARE INCLUDED

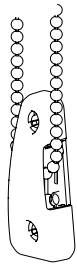

Tension Device + Chain

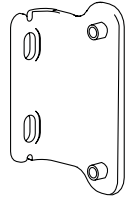

Tension Device Bracket



Short Screws



Screws

TOOLS REQUIRED

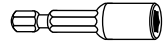

3/8" Hex Head

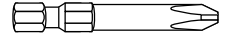

Phillips Head



1/8" Drill Bit

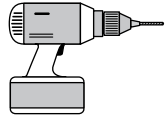

Drill

INSIDE OR OUTSIDE APPLICATION

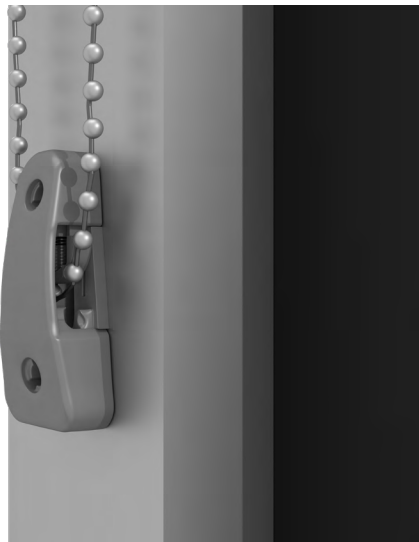
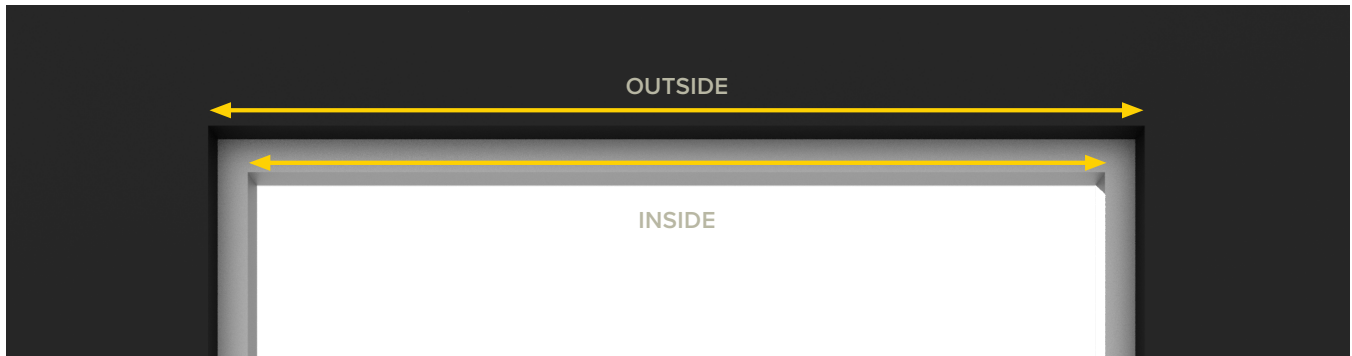

INSIDE



OUTSIDE

INSIDE MOUNT & TENSION DEVICE INSTALLATION

Pull the Chainhold down until the chain is fully tensioned (plunger will be fully raised). Screw device into wall.

A

KEEP
TENSION



B



C

SECURE
TENSION
DEVICE



NOTE: Please make sure shade operates smoothly.

OUTSIDE MOUNT & TENSION DEVICE INSTALLATION

With provided screws, install bracket first with large screws (use Chainhold marked screw hole locations as reference). Pull the Chainhold down until the chain is fully tensioned (plunger will be fully raised). Install Chainhold into bracket with small screws.

A

PULL CHAIN
DOWN &
MARK
LOCATION



B

REMOVE
TENSION
DEVICE
& DRILL

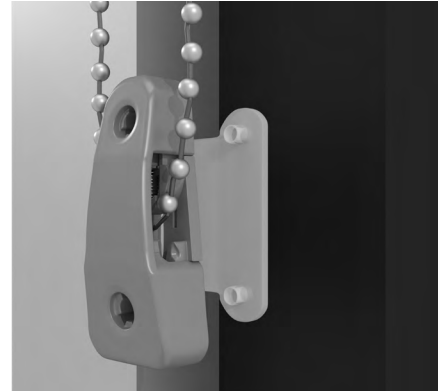

C

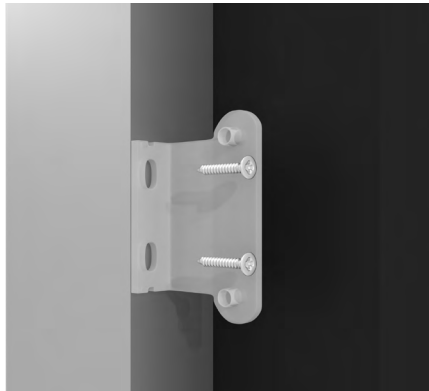

D

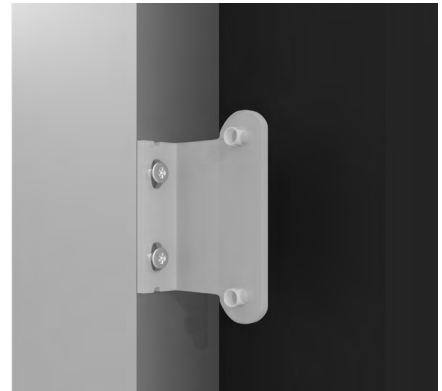

E

PLACE
TENSION
DEVICE
ON
BRACKET



F

SECURE
TENSION
DEVICE

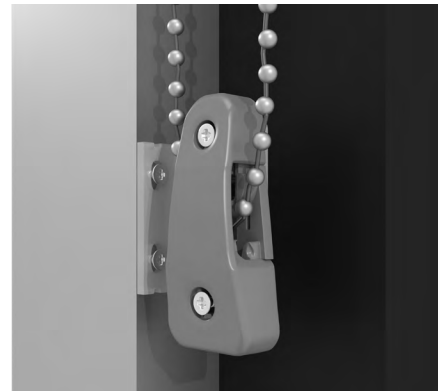

NOTE: Please make sure shade operates smoothly.